



Push-Pull Subminiatur

Push-Pull Subminiature

Kabelsteckverbinder

- Push-Pull-Verriegelung
- 3 – 8-polig
- Schutzart IP40/IP67 ¹⁾
- Lötanschluss
- Durchmesser 14,5 mm
- Schirmbar

Flanschsteckverbinder

- Push-Pull-Verriegelung
- 3 – 8 polig
- Schutzart IP40/IP67 ¹⁾
- Lötanschluss
- Durchmesser 17,5 mm
- Schirmbare Ausführungen

Cable Connectors

- Push-pull locking system
- 3 – 8 contacts
- Degree of protection IP40/IP67 ¹⁾
- Solder termination
- Diameter 14.5 mm
- Shieldable

Panel Mount Connectors

- Push-pull locking system
- 3–8 contacts
- Degree of protection IP40/IP67 ¹⁾
- Solder termination
- Diameter 17.5 mm
- Shieldable versions

¹⁾Erläuterung der Schutzarten siehe technische Informationen./ ¹⁾Explanation of protection standards see technical information.

Kabelstecker, schirmbar, IP67
Male cable connector, shieldable, IP67

Abbildung / Figure



Kabeldose, schirmbar, IP67
Female cable connector, shieldable, IP67



Maßzeichnung / Drawing

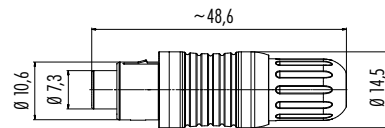
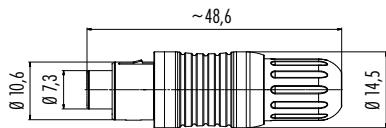

Bestell-Daten / Order Data

Polzahl Contacts	Kabeldurchlass Cable outlet	Bestell-Nr. Ordering-No.
3	3,5–5 mm	99 4905 00 03
4	3,5–5 mm	99 4909 00 04
5	3,5–5 mm	99 4913 00 05
7	3,5–5 mm	99 4925 00 07
8	3,5–5 mm	99 4929 00 08

Polzahl Contacts	Kabeldurchlass Cable outlet	Bestell-Nr. Ordering-No.
3	3,5–5 mm	99 4906 00 03
4	3,5–5 mm	99 4910 00 04
5	3,5–5 mm	99 4914 00 05
7	3,5–5 mm	99 4926 00 07
8	3,5–5 mm	99 4930 00 08

Technische Daten / Specifications

Polzahl	3	4	5	7	8	Number of contacts
Steckverbinder Verriegelung	Push-Pull					Connector locking system
Anschlussart	löten/solder					Termination
Anschlussquerschnitt	0,25 mm ² (AWG 24)			0,14 mm ² (AWG 26)		Wire gauge
Kabeldurchlass	3,5–5 mm					Cable outlet
Schutzart	IP67					Degree of protection
Mechanische Lebensdauer	> 500 Steckzyklen/> 500 mating cycles					Mechanical operation
Obere Grenztemperatur	+ 85 °C					Upper temperature
Untere Grenztemperatur	– 25 °C					Lower temperature
Bemessungsspannung	125 V					Rated voltage
Bemessungs-Stoßspannung	1500 V					Rated impulse voltage
Verschmutzungsgrad	1					Pollution degree
Überspannungskategorie	II					Overvoltage categorie
Isolierstoffgruppe	III					Material group
Bemessungsstrom (40°C)	4 A	3 A			1 A	Rated current (40 °C)
Durchgangswiderstand	≤ 3 mΩ			≤ 5 mΩ		Contact resistance
Material Kontakt	Stift/pin CuZn (Messing/brass), Buchse/socket CuSn (Bronze/bronze)					Material of contact
Kontaktoberfläche	Au (Gold/gold)					Contact plating
Material Kontaktkörper	PBT/PA					Material of contact body
Material Gehäuse	PA					Material of housing

Montageanleitung
Assembly instruction

1. Abmanteln auf L = 26mm.
Ummantlung nicht abstreifen.
2. Druckschraube und Dichtung am Kabel auffädeln.
Dichtung in Klemmvorrichtung montieren.
Ummantlung entfernen.
3. Abschirmung auffächern und auskämmen.
4. Litzen abisolieren und verzinnen.
5. Abstandshülse und Klemmvorrichtung verrasten.
6. Einsätze anlöten.
7. Abstandshülse auf Hülse stecken.
8. Klemmvorrichtung vorschieben und einrasten.
Die Abschirmlitzen in der Krone rundherum einfädeln.
9. Abschirmlitzen in Richtung Abschirmung abstreifen und kürzen.
zu lang: Litzen auf Dichtung - undicht
zu kurz: kein Kontakt zu Wellenring
10. Montierte Einheit in Trägerhülse stecken.
Druckschraube aufstecken und festziehen.

1. Strip to 26mm length but do not take off cable jacket.
2. Bead pressing screw and clamp device to cable.
Mount sealing ring to clamp device. Remove cable jacket.
3. Fan out and comb shielding braid.
4. Strip the insulation off the wires and tin them.
5. Snap in distance sleeve and clamp device.
6. Solder wires to solder cups.
7. Stick distance sleeve to sleeve.
8. Push forward and snap in clamp device.
Mount shielding braid around the crown.
9. Strip off and shorten shielding braid in the direction of the shielding ring.
too long: shielding braid on sealing ring - untight
too short: no contact to wave washer
10. Stick assembled unit into carrier sleeve and tighten pressing screw.

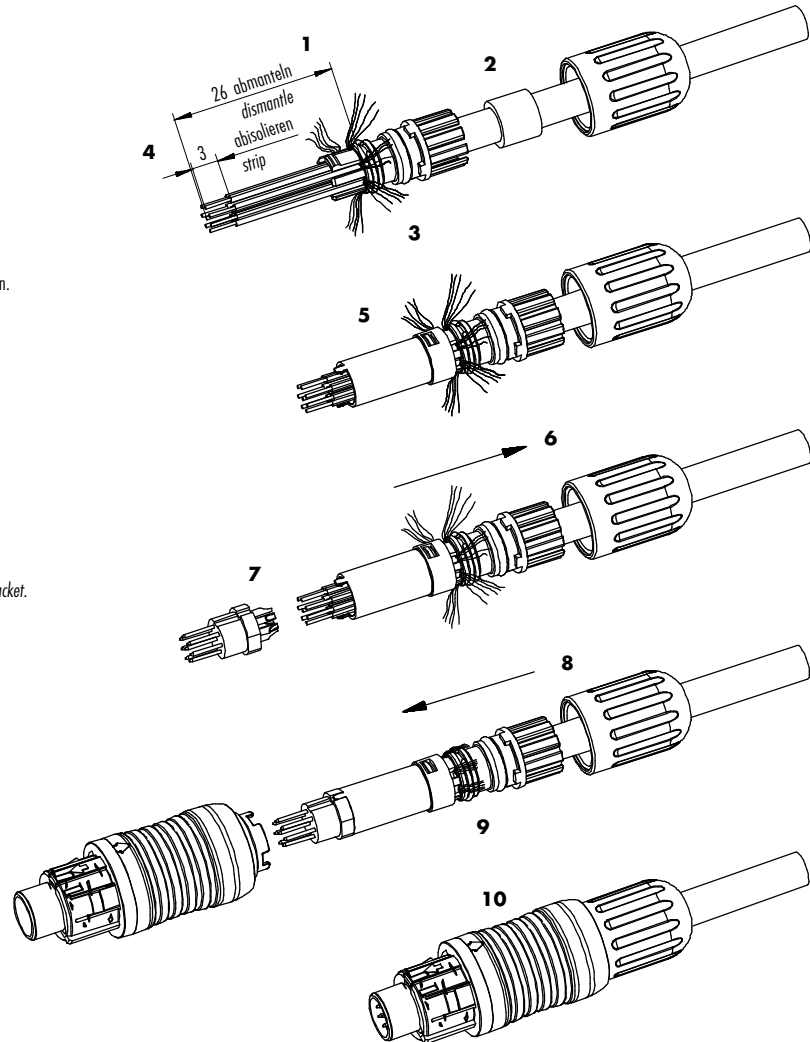

Einzelteildarstellung
Component part drawing

Kabelsteckverbinder
Cable connectors

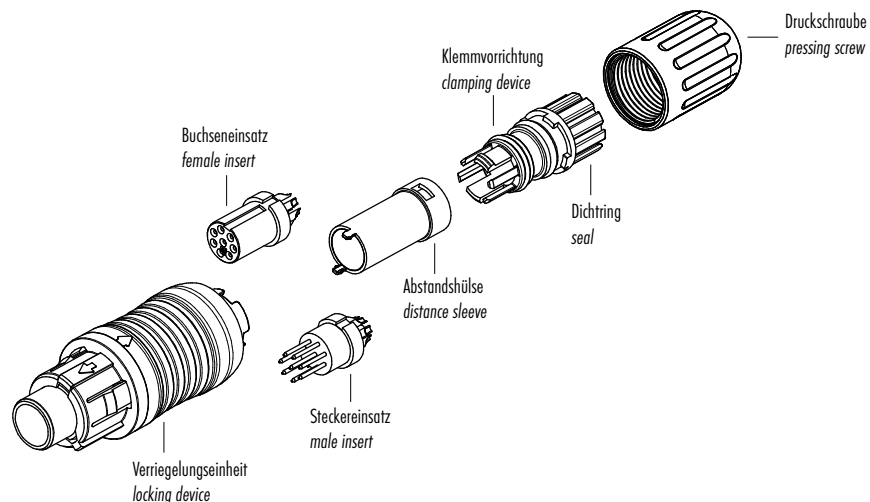

Flanschstecker, IP40

Male panel mount connector, IP40

Abbildung / Figure



Flanschstecker, IP67

Male panel mount connector, IP67



Maßzeichnung / Drawing

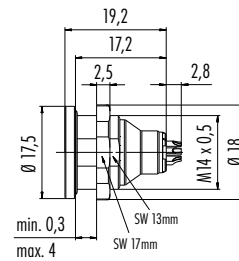
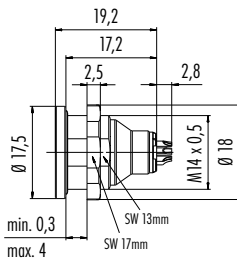

Bestell-Daten / Order Data

Polzahl Contacts	Bestell-Nr. Ordering-No.
3	09 4907 025 03
4	09 4911 025 04
5	—
7	09 4927 025 07
8	09 4931 025 08

Polzahl Contacts	Bestell-Nr. Ordering-No.
3	09 4907 015 03
4	09 4911 015 04
5	09 4915 015 05
7	09 4927 015 07
8	09 4931 015 08

Technische Daten / Specifications

Polzahl	3	4	5	7	8	Number of contacts
Steckverbinder Verriegelung	Push-Pull					Connector locking system
Anschlussart	löten/solder					Termination
Anschlussquerschnitt	0,25 mm ² (AWG 24)			0,14 mm ² (AWG 26)		Wire gauge
Kabeldurchlass	—					Cable outlet
Schutzart	IP40/IP67					Degree of protection
Mechanische Lebensdauer	> 500 Steckzyklen/> 500 mating cycles					Mechanical operation
Obere Grenztemperatur	+ 85 °C					Upper temperature
Untere Grenztemperatur	- 25 °C					Lower temperature
Bemessungsspannung	125 V					Rated voltage
Bemessungs-Stoßspannung	1500 V					Rated impulse voltage
Verschmutzungsgrad	1					Pollution degree
Überspannungskategorie	II					Overvoltage categorie
Isolierstoffgruppe	III					Material group
Bemessungsstrom (40 °C)	4 A	3 A			1 A	Rated current (40 °C)
Durchgangswiderstand	≤ 3 mΩ				≤ 5 mΩ	Contact resistance
Material Kontakt	CuZn (Messing/brass)					Material of contact
Kontaktoberfläche	Au (Gold/gold)					Contact plating
Material Kontaktkörper	PBT					Material of contact body
Material Gehäuse	CuZn (Messing vernickelt/brass nickel plated)					Material of housing

Flanschstecker, geschirmt, IP67
Male panel mount connector, shielded, IP67

Abbildung / Figure



Maßzeichnung / Drawing

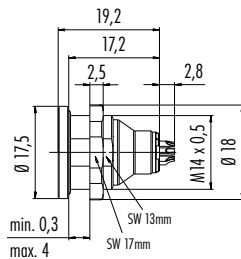

Bestell-Daten / Order Data

Polzahl Contacts	Bestell-Nr. Ordering-No.
3	09 4907 00 03
4	09 4911 00 04
5	09 4915 00 05
7	—
8	09 4931 00 08

Technische Daten / Specifications

Polzahl	3	4	5	7	8	Number of contacts
Steckverbinder Verriegelung	Push-Pull					Connector locking system
Anschlussart	löten/solder					Termination
Anschlussquerschnitt	0,25 mm ² (AWG 24)			0,14 mm ² (AWG 26)		Wire gauge
Kabeldurchlass	—					Cable outlet
Schutzart	IP67					Degree of protection
Mechanische Lebensdauer	> 500 Steckzyklen/> 500 mating cycles					Mechanical operation
Obere Grenztemperatur	+ 85 °C					Upper temperature
Untere Grenztemperatur	- 25 °C					Lower temperature
Bemessungsspannung	125 V					Rated voltage
Bemessungs-Stoßspannung	1500 V					Rated impulse voltage
Verschmutzungsgrad	1					Pollution degree
Überspannungskategorie	II					Overvoltage categorie
Isolierstoffgruppe	III					Material group
Bemessungsstrom (40°C)	4 A	3 A			1 A	Rated current (40 °C)
Durchgangswiderstand	≤ 3 mΩ			≤ 5 mΩ		Contact resistance
Material Kontakt	CuZn (Messing/brass)					Material of contact
Kontaktoberfläche	Au (Gold/gold)					Contact plating
Material Kontaktkörper	PBT					Material of contact body
Material Gehäuse	CuZn (Messing vernickelt/brass nickel plated)					Material of housing

Flanschstecker, von vorn verschraubbar, IP67
Male panel mount connector, front fastened, IP67

Flanschstecker, von vorn verschraubbar, geschirmt, IP67
Male panel mount connector, front fastened, shielded, IP67

Abbildung / Figure



Maßzeichnung / Drawing

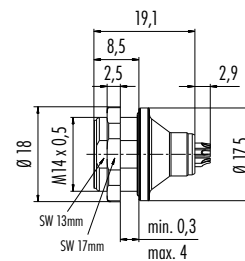
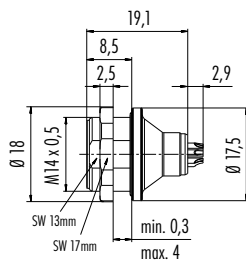

Bestell-Daten / Order Data

Polzahl Contacts	Bestell-Nr. Ordering-No.
3	09 4907 080 03
4	—
5	09 4915 080 05
7	09 4927 080 07
8	09 4931 080 08

Polzahl Contacts	Bestell-Nr. Ordering-No.
3	09 4907 081 03
4	09 4911 081 04
5	09 4915 081 05
7	09 4927 081 07
8	09 4931 081 08

Technische Daten / Specifications

Polzahl	3	4	5	7	8	Number of contacts
Steckverbinder Verriegelung	Push-Pull					Connector locking system
Anschlussart	löten/solder					Termination
Anschlussquerschnitt	0,25 mm ² (AWG 24)			0,14 mm ² (AWG 26)		Wire gauge
Kabeldurchlass	—					Cable outlet
Schutzart	IP67					Degree of protection
Mechanische Lebensdauer	> 500 Steckzyklen/> 500 mating cycles					Mechanical operation
Obere Grenztemperatur	+ 85 °C					Upper temperature
Untere Grenztemperatur	- 25 °C					Lower temperature
Bemessungsspannung	125 V					Rated voltage
Bemessungs-Stoßspannung	1500 V					Rated impulse voltage
Verschmutzungsgrad	1					Pollution degree
Überspannungskategorie	II					Overvoltage categorie
Isolierstoffgruppe	III					Material group
Bemessungsstrom (40°C)	4 A	3 A			1 A	Rated current (40 °C)
Durchgangswiderstand	≤ 3 mΩ					Contact resistance
Material Kontakt	CuZn (Messing/brass)					Material of contact
Kontaktoberfläche	Au (Gold/gold)					Contact plating
Material Kontaktkörper	PBT					Material of contact body
Material Gehäuse	CuZn (Messing vernickelt/brass nickel plated)					Material of housing

Flanschdose, IP40
Female panel mount connector, IP40

Abbildung / Figure



Flanschdose, IP67
Female panel mount connector, IP67



Maßzeichnung / Drawing

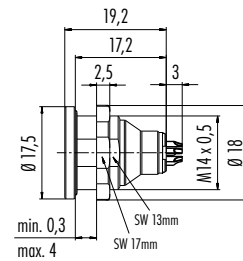
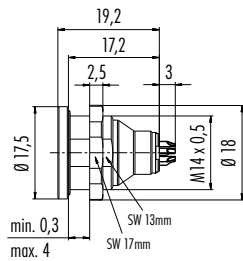

Bestell-Daten / Order Data

Polzahl Contacts	Bestell-Nr. Ordering-No.
3	09 4908 025 03
4	09 4912 025 04
5	09 4916 025 05
7	—
8	09 4932 025 08

Polzahl Contacts	Bestell-Nr. Ordering-No.
3	09 4908 015 03
4	09 4912 015 04
5	09 4916 015 05
7	09 4928 015 07
8	09 4932 015 08

Technische Daten / Specifications

Polzahl	3	4	5	7	8	Number of contacts
Steckverbinder Verriegelung	Push-Pull					Connector locking system
Anschlussart	löten/solder					Termination
Anschlussquerschnitt	0,25 mm ² (AWG 24)			0,14 mm ² (AWG 26)		Wire gauge
Kabeldurchlass	—					Cable outlet
Schutzart	IP40/IP67					Degree of protection
Mechanische Lebensdauer	> 500 Steckzyklen/> 500 mating cycles					Mechanical operation
Obere Grenztemperatur	+ 85 °C					Upper temperature
Untere Grenztemperatur	- 25 °C					Lower temperature
Bemessungsspannung	125 V					Rated voltage
Bemessungs-Stoßspannung	1500 V					Rated impulse voltage
Verschmutzungsgrad	1					Pollution degree
Überspannungskategorie	II					Overvoltage categorie
Isolierstoffgruppe	III					Material group
Bemessungsstrom (40 °C)	4 A	3 A			1 A	Rated current (40 °C)
Durchgangswiderstand	≤ 3 mΩ			≤ 5 mΩ		Contact resistance
Material Kontakt	CuSn (Bronze/bronze)					Material of contact
Kontaktoberfläche	Au (Gold/gold)					Contact plating
Material Kontaktkörper	PA					Material of contact body
Material Gehäuse	CuZn (Messing vernickelt/brass nickel plated)					Material of housing

Flanschdose, geschirmt, IP67
Female panel mount connector, shielded, IP67

Abbildung / Figure



Maßzeichnung / Drawing

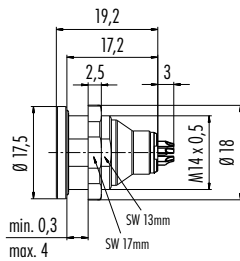

Bestell-Daten / Order Data

Polzahl Contacts	Bestell-Nr. Ordering-No.
3	09 4908 00 03
4	09 4912 00 04
5	09 4916 00 05
7	09 4928 00 07
8	09 4932 00 08

Technische Daten / Specifications

Polzahl	3	4	5	7	8	Number of contacts
Steckverbinder Verriegelung	Push-Pull					Connector locking system
Anschlussart	löten/solder					Termination
Anschlussquerschnitt	0,25 mm ² (AWG 24)			0,14 mm ² (AWG 26)		Wire gauge
Kabeldurchlass	—					Cable outlet
Schutzart	IP67					Degree of protection
Mechanische Lebensdauer	> 500 Steckzyklen/> 500 mating cycles					Mechanical operation
Obere Grenztemperatur	+ 85 °C					Upper temperature
Untere Grenztemperatur	- 25 °C					Lower temperature
Bemessungsspannung	125 V					Rated voltage
Bemessungs-Stoßspannung	1500 V					Rated impulse voltage
Verschmutzungsgrad	1					Pollution degree
Überspannungskategorie	II					Overvoltage categorie
Isolierstoffgruppe	III					Material group
Bemessungsstrom (40°C)	4 A	3 A		1 A		Rated current (40 °C)
Durchgangswiderstand	≤ 3 mΩ			≤ 5 mΩ		Contact resistance
Material Kontakt	CuSn (Bronze/bronze)					Material of contact
Kontaktoberfläche	Au (Gold/gold)					Contact plating
Material Kontaktkörper	PA					Material of contact body
Material Gehäuse	CuZn (Messing vernickelt/brass nickel plated)					Material of housing

Flanschdose, von vorn verschraubbar, IP67
Female panel mount connector, front fastened, IP67

Flanschdose, von vorn verschraubbar, geschirmt, IP67
Female panel mount connector, front fastened, shielded, IP67

Abbildung / Figure



Maßzeichnung / Drawing

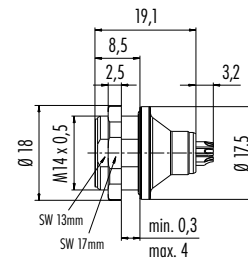
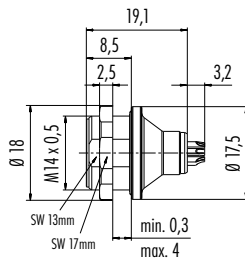

Bestell-Daten / Order Data

Polzahl Contacts	Bestell-Nr. Ordering-No.
3	09 4908 080 03
4	09 4912 080 04
5	09 4916 080 05
7	09 4928 080 07
8	09 4932 080 08

Polzahl Contacts	Bestell-Nr. Ordering-No.
3	09 4908 081 03
4	09 4912 081 04
5	09 4916 081 05
7	09 4928 081 07
8	09 4932 081 08

Technische Daten / Specifications

Polzahl	3	4	5	7	8	Number of contacts
Steckverbinder Verriegelung	Push-Pull					Connector locking system
Anschlussart	löten/solder					Termination
Anschlussquerschnitt	0,25 mm ² (AWG 24)			0,14 mm ² (AWG 26)		Wire gauge
Kabeldurchlass	—					Cable outlet
Schutzart	IP67					Degree of protection
Mechanische Lebensdauer	> 500 Steckzyklen/> 500 mating cycles					Mechanical operation
Obere Grenztemperatur	+ 85 °C					Upper temperature
Untere Grenztemperatur	- 25 °C					Lower temperature
Bemessungsspannung	125 V					Rated voltage
Bemessungs-Stoßspannung	1500 V					Rated impulse voltage
Verschmutzungsgrad	1					Pollution degree
Überspannungskategorie	II					Overvoltage categorie
Isolierstoffgruppe	III					Material group
Bemessungsstrom (40°C)	4 A	3 A		1 A		Rated current (40 °C)
Durchgangswiderstand	≤ 3 mΩ			≤ 5 mΩ		Contact resistance
Material Kontakt	CuSn (Bronze/bronze)					Material of contact
Kontaktoberfläche	Au (Gold/gold)					Contact plating
Material Kontaktkörper	PA					Material of contact body
Material Gehäuse	CuZn (Messing vernickelt/brass nickel plated)					Material of housing

Einzelteildarstellung
Component part drawing

Flanschsteckverbinder
Panel mount connectors

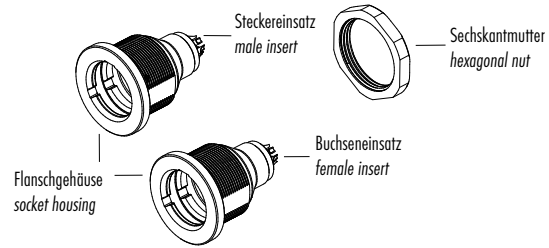

Polbilder
Contact arrangements

Stifteinsatz (Steckseite)
Male insert (mating side)

Buchseinsatz (Steckseite)
Female insert (mating side)

3 pol
3 contacts

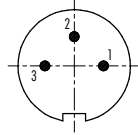

	X	Y
1	1,55	0,00
2	0,00	1,55
3	-1,55	0,00

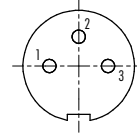

	X	Y
1	-1,55	0,00
2	0,00	1,55
3	1,55	0,00

4 pol
4 contacts

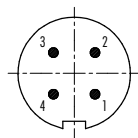

	X	Y
1	1,11	-1,11
2	1,11	1,11
3	-1,11	1,11
4	-1,11	-1,11

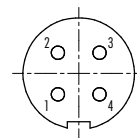

	X	Y
1	-1,11	-1,11
2	-1,11	1,11
3	1,11	1,11
4	1,11	-1,11

5 pol
5 contacts

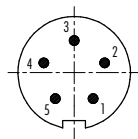

	X	Y
1	1,00	-1,37
2	1,61	0,52
3	0,00	1,70
4	-1,61	0,52
5	-1,00	-1,37

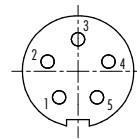

	X	Y
1	-1,00	-1,37
2	-1,61	0,52
3	0,00	1,70
4	1,61	0,52
5	1,00	-1,37

7 pol
7 contacts

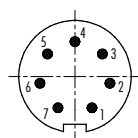

	X	Y
1	0,90	-1,65
2	1,85	-0,35
3	1,45	1,20
4	0,00	1,85
5	-1,45	1,20
6	-1,85	-0,35
7	-0,90	-1,65

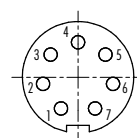

	X	Y
1	0,90	-1,65
2	1,85	-0,35
3	1,45	1,20
4	0,00	1,85
5	-1,45	1,20
6	-1,85	-0,35
7	-0,90	-1,65

8 pol
8 contacts

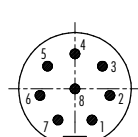

	X	Y
1	0,90	-1,65
2	1,85	-0,35
3	1,45	1,20
4	0,00	1,85
5	-1,45	1,20
6	-1,85	-0,35
7	-0,90	-1,65
8	0,00	0,00

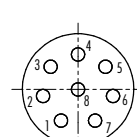

	X	Y
1	-0,90	-1,65
2	-1,85	-0,35
3	-1,45	1,20
4	0,00	1,85
5	1,45	1,20
6	1,85	-0,35
7	0,90	-1,65
8	0,00	0,00

Montageausschnitt
Panel cut out

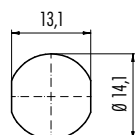

Schutzkappe für Kabelsteckverbinder
Protection cap for cable connectors

Abbildung / Figure



Maßzeichnung / Drawing

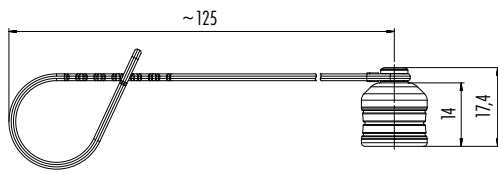

Bestell-Daten / Order Data

Bestell-Nr.
Ordering-No.

08 2965 000 000

Schutzkappe für Flanschsteckverbinder
Protection cap for panel mount connectors

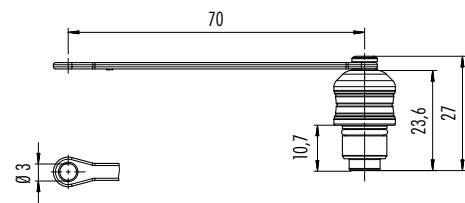

Bestell-Nr.
Ordering-No.

08 2966 000 000

