



## M16 Miniatur IP40

### M16 Miniature IP40

#### Kabelsteckverbinder

- Schraubverriegelung M16
- 2 – 24-polig
- Schutzart IP40 <sup>1)</sup>
- Löt-/Crimp-/Schraubklemmanschluss
- Durchmesser 17,2 mm/17,5 mm/18,5 mm/20 mm
- Schirmbare Ausführungen
- Nach DIN EN 61076-2-106

#### Flanschsteckverbinder

- Schraubverriegelung M16
- 2 – 24-polig
- Schutzart IP40 <sup>1)</sup>
- Löt-/Tauchlöt-/Crimpanschluss/Litzen
- Durchmesser 20 mm
- Schirmbare Ausführungen
- Nach DIN EN 61076-2-106

#### Cable Connectors

- Screw termination M16
- 2 – 24 contacts
- Degree of protection IP40 <sup>1)</sup>
- Solder/crimp/screw clamp termination
- Diameter 17.2 mm/17.5 mm/18.5 mm/20 mm
- Shieldable versions
- Acc. to DIN EN 61076-2-106

#### Panel Mount Connectors

- Screw termination M16
- 2 – 24 contacts
- Degree of protection IP40 <sup>1)</sup>
- Solder/dip solder/crimp termination/single wires
- Diameter 20 mm
- Shieldable versions
- Acc. to DIN EN 61076-2-106

<sup>1)</sup>Erläuterung der Schutzarten siehe technische Informationen./ <sup>1)</sup>Explanation of protection standards see technical information.

Kabelstecker mit Lötöse, schirmbar  
Male cable connector with solder eye ring, shieldable

Abbildung / Figure



Maßzeichnung / Drawing

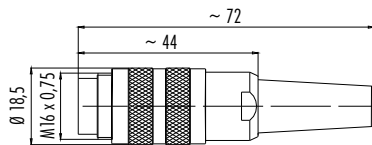

Kabelstecker mit Lötöse, schirmbar  
Male cable connector with solder eye ring, shieldable

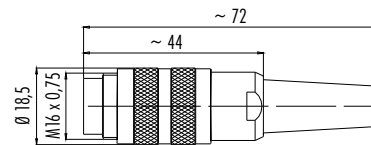

Bestell-Daten / Order Data

Polzahl Contacts	Kabeldurchlass Cable outlet	Versilberte Kontakte Silver plated contacts	Vergoldete Kontakte Gold plated contacts
2	4–6 mm	99 2001 00 02	99 2001 09 02
3 DIN	4–6 mm	99 2005 00 03	99 2005 09 03
4	4–6 mm	99 2009 00 04	99 2009 09 04
5	4–6 mm	99 2013 00 05	99 2013 09 05
5 (Stereo)	4–6 mm	99 2017 00 05	99 2017 09 05
6 DIN	4–6 mm	99 2021 00 06	99 2021 09 06
7	4–6 mm	99 2025 00 07	99 2025 09 07
7 DIN	4–6 mm	99 2581 00 07	– <sup>1)</sup>
8 DIN	4–6 mm	99 2061 00 08	99 2061 09 08
12	4–6 mm	–	99 2029 00 12
14	4–6 mm	–	99 2033 00 14
16	4–6 mm	–	99 2037 00 16
19	4–6 mm	–	99 2041 00 19
24	4–6 mm	–	–

Polzahl Contacts	Kabeldurchlass Cable outlet	Versilberte Kontakte Silver plated contacts	Vergoldete Kontakte Gold plated contacts
2	6–8 mm	99 2001 02 02	99 2001 92 02
3 DIN	6–8 mm	99 2005 02 03	99 2005 92 03
4	6–8 mm	99 2009 02 04	99 2009 92 04
5	6–8 mm	99 2013 02 05	99 2013 92 05
5 (Stereo)	6–8 mm	99 2017 02 05	99 2017 92 05
6 DIN	6–8 mm	99 2021 02 06	99 2021 92 06
7	6–8 mm	99 2025 02 07	99 2025 92 07
7 DIN	6–8 mm	– <sup>1)</sup>	– <sup>1)</sup>
8 DIN	6–8 mm	99 2061 02 08	99 2061 92 08
12	6–8 mm	–	99 2029 02 12
14	6–8 mm	–	99 2033 02 14
16	6–8 mm	–	99 2037 02 16
19	6–8 mm	–	99 2041 02 19
24	6–8 mm	–	99 2045 02 24

Technische Daten / Specifications

Polzahl	2	3 DIN	4	5	5 (Stereo)	6 DIN	7	7 DIN	8 DIN	12	14	16	19	24	Number of contacts
Steckverbinder Verriegelung	schrauben/screw														Connector locking system
Anschlussart	löten/solder														Termination
Anschlussquerschnitt	max. 0,75 mm <sup>2</sup> (max. AWG 18)										max. 0,25 mm <sup>2</sup> (max. AWG 24)		0,14 mm <sup>2</sup> (26)		Wire gauge
Kabeldurchlass	4–6 mm, 6–8 mm														Cable outlet
Schutzart	IP40														Degree of protection
Mechanische Lebensdauer	> 500 Steckzyklen/> 500 mating cycles														Mechanical operation
Obere Grenztemperatur	+ 85 °C														Upper temperature
Untere Grenztemperatur	– 40 °C														Lower temperature
Bemessungsspannung	150 V (250 V)				32 V (60 V)		150 V (250 V)		32 V (125 V)		32 V (60 V)				Rated voltage
Bemessungs-Stoßspannung	1500 V				500 V		1500 V		500 V (800 V)		500 V				Rated impulse voltage
Verschmutzungsgrad	2 (1) <sup>2)</sup>														Pollution degree
Überspannungskategorie	II (I) <sup>2)</sup>														Overvoltage categorie
Isolierstoffgruppe	III														Material group
Bemessungsstrom (40 °C)	7 A			6 A			5 A			3 A			1 A		Rated current (40 °C)
Durchgangswiderstand	≤ 5 mΩ														Contact resistance
Material Kontakt	CuZn (Messing/brass)														Material of contact
Kontaktoberfläche	Ag (Silber/silver)/Au (Gold/gold)										Au (Gold/gold)				Contact plating
Material Kontaktkörper	PBT														Material of contact body
Material Gehäuse	CuZn (Messing, vernickelt/brass, nickel plated)														Material of housing

**Kabelstecker mit Kabelklemme, schirmbar**  
Male cable connector with cable clamp, shieldable

Abbildung / Figure



**Kabelstecker mit Kabelklemme, schirmbar**  
Male cable connector with cable clamp, shieldable



Maßzeichnung / Drawing

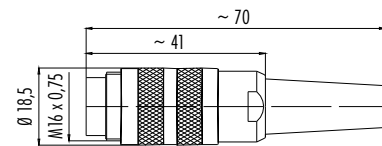
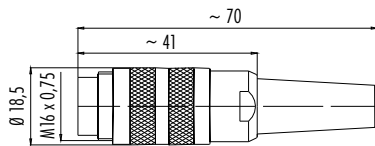

Bestell-Daten / Order Data

Polzahl Contacts	Kabeldurchlass Cable outlet	Versilberte Kontakte Silver plated contacts	Vergoldete Kontakte Gold plated contacts
2	4–6 mm	99 2001 10 02	99 2001 19 02
3 DIN	4–6 mm	99 2005 10 03	– <sup>1)</sup>
4	4–6 mm	99 2009 10 04	– <sup>1)</sup>
5	4–6 mm	99 2013 10 05	99 2013 19 05
5 (Stereo)	4–6 mm	99 2017 10 05	– <sup>1)</sup>
6 DIN	4–6 mm	99 2021 10 06	99 2021 19 06
7	4–6 mm	99 2025 10 07	99 2025 19 07
7 DIN	4–6 mm	– <sup>1)</sup>	– <sup>1)</sup>
8 DIN	4–6 mm	99 2061 10 08	– <sup>1)</sup>
12	4–6 mm	–	99 2029 10 12
14	4–6 mm	–	99 2033 10 14
16	4–6 mm	–	99 2037 10 16
19	4–6 mm	–	99 2041 10 19
24	4–6 mm	–	–

Polzahl Contacts	Kabeldurchlass Cable outlet	Versilberte Kontakte Silver plated contacts	Vergoldete Kontakte Gold plated contacts
2	6–8 mm	99 2001 20 02	99 2001 29 02
3 DIN	6–8 mm	99 2005 20 03	99 2005 29 03
4	6–8 mm	99 2009 20 04	99 2009 29 04
5	6–8 mm	99 2013 20 05	99 2013 29 05
5 (Stereo)	6–8 mm	99 2017 20 05	– <sup>1)</sup>
6 DIN	6–8 mm	99 2021 20 06	99 2021 29 06
7	6–8 mm	99 2025 20 07	99 2025 29 07
7 DIN	6–8 mm	– <sup>1)</sup>	– <sup>1)</sup>
8 DIN	6–8 mm	99 2061 20 08	99 2061 29 08
12	6–8 mm	–	99 2029 20 12
14	6–8 mm	–	99 2033 20 14
16	6–8 mm	–	99 2037 20 16
19	6–8 mm	–	99 2041 20 19
24	6–8 mm	–	99 2045 20 24

Technische Daten / Specifications

Polzahl	2	3 DIN	4	5	5 (Stereo)	6 DIN	7	7 DIN	8 DIN	12	14	16	19	24	Number of contacts
Steckverbinder Verriegelung	schrauben/screw														Connector locking system
Anschlussart	löten/solder														Termination
Anschlussquerschnitt	max. 0,75 mm <sup>2</sup> (max. AWG 18)							max. 0,25 mm <sup>2</sup> (max. AWG 24)			0,14 mm <sup>2</sup> (26)				Wire gauge
Kabeldurchlass	4–6 mm, 6–8 mm														Cable outlet
Schutzart	IP40														Degree of protection
Mechanische Lebensdauer	> 500 Steckzyklen/> 500 mating cycles														Mechanical operation
Obere Grenztemperatur	+ 85 °C														Upper temperature
Untere Grenztemperatur	– 40 °C														Lower temperature
Bemessungsspannung	150 V (250 V)			32 V (60 V)		150 V (250 V)		32 V (125 V)		32 V (60 V)				Rated voltage	
Bemessungs-Stoßspannung	1500 V			500 V		1500 V		500 V (800 V)		500 V				Rated impulse voltage	
Verschmutzungsgrad	2 (1) <sup>2)</sup>														Pollution degree
Überspannungskategorie	II (I) <sup>2)</sup>														Overvoltage categorie
Isolierstoffgruppe	III														Material group
Bemessungsstrom (40 °C)	7 A		6 A			5 A			3 A			1 A			Rated current (40 °C)
Durchgangswiderstand	≤ 5 mΩ							≤ 3 mΩ							Contact resistance
Material Kontakt	CuZn (Messing/brass)														Material of contact
Kontaktoberfläche	Ag (Silber/silver)/Au (Gold/gold)							Au (Gold/gold)							Contact plating
Material Kontaktkörper	PBT														Material of contact body
Material Gehäuse	CuZn (Messing, vernickelt/brass, nickel plated)														Material of housing

<sup>1)</sup> Auf Anfrage. / <sup>1)</sup> Upon request.

<sup>2)</sup> Bei Verschm.grad 1, Übersp.kat. I erhöhte Bemessungsspannung. / <sup>2)</sup> In case of pollution degree 1, overvoltage category I rated voltage is increased.

**Kabelstecker mit Kabelklemme, Schraubklemmanschluss, schirmbar**  
Male cable connector with cable clamp, screw clamp connection, shieldable

**Kabelstecker mit Kabelklemme, Schraubklemmanschluss, schirmbar**  
Male cable connector with cable clamp, screw clamp connection, shieldable

Abbildung / Figure



Maßzeichnung / Drawing

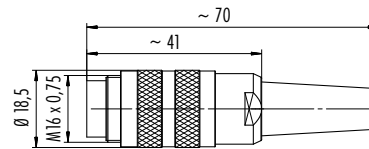
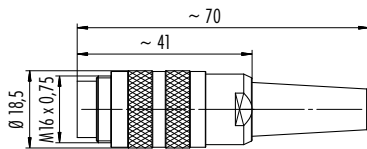

Bestell-Daten / Order Data

Polzahl Contacts	Kabeldurchlass Cable outlet	Bestell-Nr. Ordering-No.
3 DIN	4–6 mm	99 2005 210 03
4	4–6 mm	99 2009 210 04
5	4–6 mm	99 2013 210 05

Polzahl Contacts	Kabeldurchlass Cable outlet	Bestell-Nr. Ordering-No.
3 DIN	6–8 mm	99 2005 220 03
4	6–8 mm	99 2009 220 04
5	6–8 mm	99 2013 220 05

Technische Daten / Specifications

Polzahl	3 DIN	4	5	Number of contacts
Steckverbinder Verriegelung		schrauben/screw		Connector locking system
Anschlussart		schrauben/screw		Termination
Anschlussquerschnitt		0,25 mm <sup>2</sup> –1,5 mm <sup>2</sup> (AWG 24–AWG 16)		Wire gauge
Kabeldurchlass		4–6 mm, 6–8 mm		Cable outlet
Schutzart		IP40		Degree of protection
Mechanische Lebensdauer		> 500 Steckzyklen/> 500 mating cycles		Mechanical operation
Obere Grenztemperatur		+ 85 °C		Upper temperature
Untere Grenztemperatur		– 40 °C		Lower temperature
Bemessungsspannung	150 V		100 V	Rated voltage
Bemessungs-Stoßspannung	1500 V		800 V	Rated impulse voltage
Verschmutzungsgrad		2		Pollution degree
Überspannungskategorie		II		Overvoltage categorie
Isolierstoffgruppe		II		Material group
Bemessungsstrom (40 °C)	7 A		6 A	Rated current (40 °C)
Durchgangswiderstand		≤ 5 mΩ		Contact resistance
Material Kontakt		CuZn (Messing/brass)		Material of contact
Kontaktoberfläche		Ag (Silber/silver)		Contact plating
Material Kontaktkörper		PBT		Material of contact body
Material Gehäuse		CuZn (Messing, vernickelt/brass, nickel plated)		Material of housing

**Kabelstecker mit Kabelklemme, Crimpanschluss, schirmbar**  
Male cable connector with cable clamp, crimp connection, shieldable

Abbildung / Figure



Crimp- und Bandkontakte siehe Seite 208  
Crimp and strip contacts see page 208

Maßzeichnung / Drawing

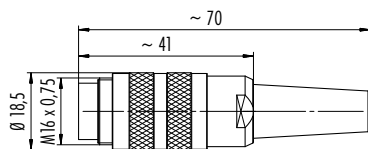

Bestell-Daten / Order Data

Polzahl Contacts	Kabeldurchlass Cable outlet	Bestell-Nr. Ordering-No.
4	4–6 mm	99 2009 700 04
5	4–6 mm	99 2013 700 05
6 DIN	4–6 mm	99 2021 700 06
7	4–6 mm	99 2025 700 07
8 DIN	4–6 mm	99 2061 700 08

**Kabelstecker mit Kabelklemme, Crimpanschluss, schirmbar**  
Male cable connector with cable clamp, crimp connection, shieldable

Abbildung / Figure



Crimp- und Bandkontakte siehe Seite 208  
Crimp and strip contacts see page 208

Maßzeichnung / Drawing

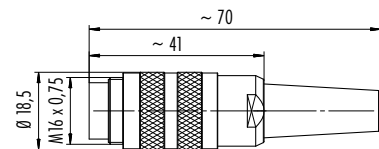

Bestell-Daten / Order Data

Polzahl Contacts	Kabeldurchlass Cable outlet	Bestell-Nr. Ordering-No.
4	6–8 mm	99 2009 702 04
5	6–8 mm	99 2013 702 05
6 DIN	6–8 mm	99 2021 702 06
7	6–8 mm	99 2025 702 07
8 DIN	6–8 mm	99 2061 702 08

Technische Daten / Specifications

Polzahl	4	5	6 DIN	7	8 DIN	Number of contacts
Steckverbinder Verriegelung	schrauben/screw					Connector locking system
Anschlussart	crimpen/crimp					Termination
Anschlussquerschnitt	4–6 pol. 0,14 mm <sup>2</sup> –1,0 mm <sup>2</sup> (AWG 26–AWG 18), 7+8 pol. 0,14 mm <sup>2</sup> –0,75 mm <sup>2</sup> (AWG 26–AWG 20)					Wire gauge
Kabeldurchlass	4–6 mm, 6–8 mm					Cable outlet
Schutzart	IP40					Degree of protection
Mechanische Lebensdauer	> 500 Steckzyklen/> 500 mating cycles					Mechanical operation
Obere Grenztemperatur	+ 100 °C					Upper temperature
Untere Grenztemperatur	– 40 °C					Lower temperature
Bemessungsspannung	150 V (250 V)		32 V (125 V)		32 V (60 V)	Rated voltage
Bemessungs-Stoßspannung	1500 V		500 V (800 V)		500 V	Rated impulse voltage
Verschmutzungsgrad	2 (I) <sup>1)</sup>					Pollution degree
Überspannungskategorie	II (I) <sup>1)</sup>					Overvoltage categorie
Isolierstoffgruppe	II					Material group
Bemessungsstrom (40°C)	6 A		5 A			Rated current (40 °C)
Durchgangswiderstand	≤ 5 mΩ					Contact resistance
Material Kontakt	—					Material of contact
Kontaktoberfläche	Siehe Crimpkontakte Seite 208./See crimp contacts page 208.					Contact plating
Material Kontaktkörper	PBT					Material of contact body
Material Gehäuse	CuZn (Messing, vernickelt/brass, nickel plated)					Material of housing

<sup>1)</sup> Bei Verschm.grad 1, Übersp.kat. I erhöhte Bemessungsspannung. / <sup>1)</sup> In case of pollution degree 1, overvoltage category I rated voltage is increased.

**Kabeldose mit Lötöse, schirmbar**  
Female cable connector with solder eye ring, shieldable

**Kabeldose mit Lötöse, schirmbar**  
Female cable connector with solder eye ring, shieldable

Abbildung / Figure



Maßzeichnung / Drawing

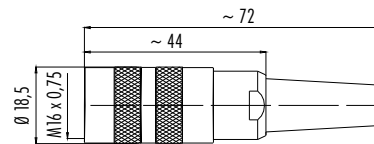
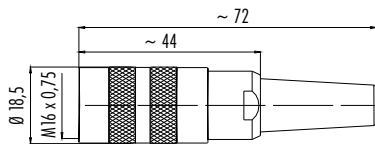

Bestell-Daten / Order Data

Polzahl Contacts	Kabeldurchlass Cable outlet	Versilberte Kontakte Silver plated contacts	Vergoldete Kontakte Gold plated contacts
2	4–6 mm	99 2002 00 02	99 2002 09 02
3 DIN	4–6 mm	99 2006 00 03	99 2006 09 03
4	4–6 mm	99 2010 00 04	99 2010 09 04
5	4–6 mm	99 2014 00 05	99 2014 09 05
5 (Stereo)	4–6 mm	99 2018 00 05	99 2018 09 05
6 DIN	4–6 mm	99 2022 00 06	99 2022 09 06
7	4–6 mm	99 2026 00 07	99 2026 09 07
7 DIN	4–6 mm	99 2582 00 07	– <sup>1)</sup>
8 DIN	4–6 mm	99 2062 00 08	99 2062 09 08
12	4–6 mm	–	99 2030 00 12
14	4–6 mm	–	99 2034 00 14
16	4–6 mm	–	99 2038 00 16
19	4–6 mm	–	99 2042 00 19
24	4–6 mm	–	–

Polzahl Contacts	Kabeldurchlass Cable outlet	Versilberte Kontakte Silver plated contacts	Vergoldete Kontakte Gold plated contacts
2	6–8 mm	99 2002 02 02	99 2002 92 02
3 DIN	6–8 mm	99 2006 02 03	99 2006 92 03
4	6–8 mm	99 2010 02 04	99 2010 92 04
5	6–8 mm	99 2014 02 05	99 2014 92 05
5 (Stereo)	6–8 mm	99 2018 02 05	99 2018 92 05
6 DIN	6–8 mm	99 2022 02 06	99 2022 92 06
7	6–8 mm	99 2026 02 07	99 2026 92 07
7 DIN	6–8 mm	– <sup>1)</sup>	– <sup>1)</sup>
8 DIN	6–8 mm	99 2062 02 08	99 2062 92 08
12	6–8 mm	–	99 2030 02 12
14	6–8 mm	–	99 2034 02 14
16	6–8 mm	–	99 2038 02 16
19	6–8 mm	–	99 2042 02 19
24	6–8 mm	–	99 2046 02 24

Technische Daten / Specifications

Polzahl	2	3 DIN	4	5	5 (Stereo)	6 DIN	7	7 DIN	8 DIN	12	14	16	19	24	Number of contacts	
Steckverbinder Verriegelung	schrauben/screw														Connector locking system	
Anschlussart	löten/solder														Termination	
Anschlussquerschnitt	max. 0,75 mm <sup>2</sup> (max. AWG 18)							max. 0,25 mm <sup>2</sup> (max. AWG 24)				0,14 mm <sup>2</sup> (26)				Wire gauge
Kabeldurchlass	4–6 mm, 6–8 mm														Cable outlet	
Schutzart	IP40														Degree of protection	
Mechanische Lebensdauer	> 500 Steckzyklen/> 500 mating cycles														Mechanical operation	
Obere Grenztemperatur	+ 85 °C														Upper temperature	
Untere Grenztemperatur	– 40 °C														Lower temperature	
Bemessungsspannung	150 V (250 V)			32 V (60 V)		150 V (250 V)		32 V (125 V)		32 V (60 V)						Rated voltage
Bemessungs-Stoßspannung	1500 V			500 V		1500 V		500 V (800 V)		500 V						Rated impulse voltage
Verschmutzungsgrad	2 (1) <sup>2)</sup>														Pollution degree	
Überspannungskategorie	II (I) <sup>2)</sup>														Overvoltage categorie	
Isolierstoffgruppe	III														Material group	
Bemessungsstrom (40 °C)	7 A		6 A			5 A						3 A		1 A		Rated current (40 °C)
Durchgangswiderstand	≤ 5 mΩ														Contact resistance	
Material Kontakt	CuSn (Bronze/bronze)														Material of contact	
Kontaktoberfläche	Ag (Silber/silver)/Au (Gold/gold)									Au (Gold/gold)						Contact plating
Material Kontaktkörper	PBT														Material of contact body	
Material Gehäuse	CuZn (Messing, vernickelt/brass, nickel plated)														Material of housing	

**Kabeldose mit Kabelklemme, schirmbar**  
Female cable connector with cable clamp, shieldable

Abbildung / Figure



**Kabeldose mit Kabelklemme, schirmbar**  
Female cable connector with cable clamp, shieldable



Maßzeichnung / Drawing

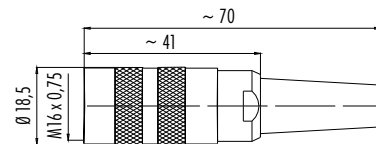
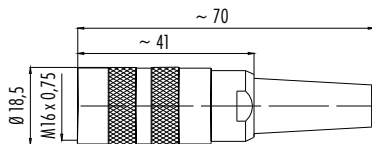

Bestell-Daten / Order Data

Polzahl Contacts	Kabeldurchlass Cable outlet	Versilberte Kontakte Silver plated contacts	Vergoldete Kontakte Gold plated contacts
2	4–6 mm	99 2002 10 02	99 2002 19 02
3 DIN	4–6 mm	99 2006 10 03	99 2006 19 03
4	4–6 mm	99 2010 10 04	– <sup>1)</sup>
5	4–6 mm	99 2014 10 05	99 2014 19 05
5 (Stereo)	4–6 mm	99 2018 10 05	– <sup>1)</sup>
6 DIN	4–6 mm	99 2022 10 06	99 2022 19 06
7	4–6 mm	99 2026 10 07	99 2026 19 07
7 DIN	4–6 mm	– <sup>1)</sup>	– <sup>1)</sup>
8 DIN	4–6 mm	99 2062 10 08	– <sup>1)</sup>
12	4–6 mm	–	99 2030 10 12
14	4–6 mm	–	99 2034 10 14
16	4–6 mm	–	99 2038 10 16
19	4–6 mm	–	99 2042 10 19
24	4–6 mm	–	–

Polzahl Contacts	Kabeldurchlass Cable outlet	Versilberte Kontakte Silver plated contacts	Vergoldete Kontakte Gold plated contacts
2	6–8 mm	99 2002 20 02	99 2002 29 02
3 DIN	6–8 mm	99 2006 20 03	99 2006 29 03
4	6–8 mm	99 2010 20 04	99 2010 29 04
5	6–8 mm	99 2014 20 05	99 2014 29 05
5 (Stereo)	6–8 mm	99 2018 20 05	– <sup>1)</sup>
6 DIN	6–8 mm	99 2022 20 06	99 2022 29 06
7	6–8 mm	99 2026 20 07	99 2026 29 07
7 DIN	6–8 mm	– <sup>1)</sup>	– <sup>1)</sup>
8 DIN	6–8 mm	99 2062 20 08	99 2062 29 08
12	6–8 mm	–	99 2030 20 12
14	6–8 mm	–	99 2034 20 14
16	6–8 mm	–	99 2038 20 16
19	6–8 mm	–	99 2042 20 19
24	6–8 mm	–	99 2046 20 24

Technische Daten / Specifications

Polzahl	2	3 DIN	4	5	5 (Stereo)	6 DIN	7	7 DIN	8 DIN	12	14	16	19	24	Number of contacts	
Steckverbinder Verriegelung	schrauben/screw														Connector locking system	
Anschlussart	löten/solder														Termination	
Anschlussquerschnitt	max. 0,75 mm <sup>2</sup> (max. AWG 18)							max. 0,25 mm <sup>2</sup> (max. AWG 24)				0,14 mm <sup>2</sup> (26)			Wire gauge	
Kabeldurchlass	4–6 mm, 6–8 mm														Cable outlet	
Schutzart	IP40														Degree of protection	
Mechanische Lebensdauer	> 500 Steckzyklen/> 500 mating cycles														Mechanical operation	
Obere Grenztemperatur	+ 85 °C														Upper temperature	
Untere Grenztemperatur	– 40 °C														Lower temperature	
Bemessungsspannung	150 V (250 V)			32 V (60 V)		150 V (250 V)		32 V (125 V)		32 V (60 V)						Rated voltage
Bemessungs-Stoßspannung	1500 V			500 V		1500 V		500 V (800 V)		500 V						Rated impulse voltage
Verschmutzungsgrad	2 (I) <sup>2)</sup>														Pollution degree	
Überspannungskategorie	II (I) <sup>2)</sup>														Overvoltage categorie	
Isolierstoffgruppe	III														Material group	
Bemessungsstrom (40 °C)	7 A		6 A			5 A			3 A			1 A			Rated current (40 °C)	
Durchgangswiderstand	≤ 5 mΩ							≤ 3 mΩ							Contact resistance	
Material Kontakt	CuSn (Bronze/bronze)														Material of contact	
Kontaktoberfläche	Ag (Silber/silver)/Au (Gold/gold)							Au (Gold/gold)							Contact plating	
Material Kontaktkörper	PBT														Material of contact body	
Material Gehäuse	CuZn (Messing, vernickelt/brass, nickel plated)														Material of housing	

<sup>1)</sup> Auf Anfrage. / <sup>1)</sup> Upon request.

<sup>2)</sup> Bei Verschm.grad 1, Übersp.kat. I erhöhte Bemessungsspannung. / <sup>2)</sup> In case of pollution degree 1, overvoltage category I rated voltage is increased.

**Kabeldose mit Kabelklemme, Schraubklemmanschluss, schirmbar**  
Female cable connector with cable clamp, screw clamp connection, shieldable

Abbildung / Figure



**Kabeldose mit Kabelklemme, Schraubklemmanschluss, schirmbar**  
Female cable connector with cable clamp, screw clamp connection, shieldable



Maßzeichnung / Drawing

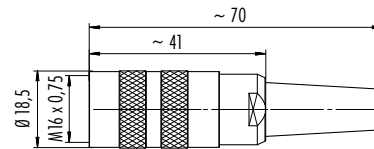
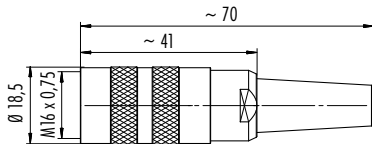

Bestell-Daten / Order Data

Polzahl Contacts	Kabeldurchlass Cable outlet	Bestell-Nr. Ordering-No.
3 DIN	4–6 mm	99 2006 210 03
4	4–6 mm	99 2010 210 04
5	4–6 mm	99 2014 210 05

Polzahl Contacts	Kabeldurchlass Cable outlet	Bestell-Nr. Ordering-No.
3 DIN	6–8 mm	99 2006 220 03
4	6–8 mm	99 2010 220 04
5	6–8 mm	99 2014 220 05

Technische Daten / Specifications

Polzahl	3 DIN	4	5	Number of contacts
Steckverbinder Verriegelung		schrauben/screw		Connector locking system
Anschlussart		schrauben/screw		Termination
Anschlussquerschnitt		0,25 mm <sup>2</sup> –1,5 mm <sup>2</sup> (AWG 24–AWG 16)		Wire gauge
Kabeldurchlass		4–6 mm, 6–8 mm		Cable outlet
Schutzart		IP40		Degree of protection
Mechanische Lebensdauer		> 500 Steckzyklen/> 500 mating cycles		Mechanical operation
Obere Grenztemperatur		+ 85 °C		Upper temperature
Untere Grenztemperatur		– 40 °C		Lower temperature
Bemessungsspannung	150 V		100 V	Rated voltage
Bemessungs-Stoßspannung	1500 V		800 V	Rated impulse voltage
Verschmutzungsgrad		2		Pollution degree
Überspannungskategorie		II		Overvoltage categorie
Isolierstoffgruppe		II		Material group
Bemessungsstrom (40 °C)	7 A		6 A	Rated current (40 °C)
Durchgangswiderstand		≤ 5 mΩ		Contact resistance
Material Kontakt		CuSn (Bronze/bronze)		Material of contact
Kontaktoberfläche		Ag (Silber/silver)/Au (Gold/gold)		Contact plating
Material Kontaktkörper		PBT		Material of contact body
Material Gehäuse		CuZn (Messing, vernickelt/brass, nickel plated)		Material of housing



**Kabeldose mit Kabelklemme, Crimpanschluss, schirmbar**  
Female cable connector with cable clamp, crimp connection, shieldable

Abbildung / Figure



Crimp- und Bandkontakte siehe Seite 208  
Crimp and strip contacts see page 208

**Kabeldose mit Kabelklemme, Crimpanschluss, schirmbar**  
Female cable connector with cable clamp, crimp connection, shieldable



Crimp- und Bandkontakte siehe Seite 208  
Crimp and strip contacts see page 208

Maßzeichnung / Drawing

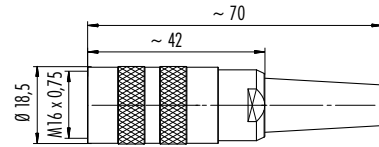
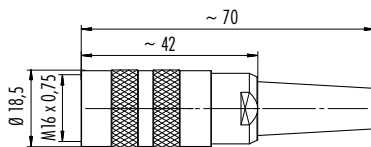

Bestell-Daten / Order Data

Polzahl Contacts	Kabeldurchlass Cable outlet	Bestell-Nr. Ordering-No.
4	4–6 mm	99 2010 700 04
5	4–6 mm	99 2014 700 05
6 DIN	4–6 mm	99 2022 700 06
7	4–6 mm	99 2026 700 07
8 DIN	4–6 mm	99 2062 700 08

Polzahl Contacts	Kabeldurchlass Cable outlet	Bestell-Nr. Ordering-No.
4	6–8 mm	99 2010 702 04
5	6–8 mm	99 2014 702 05
6 DIN	6–8 mm	99 2022 702 06
7	6–8 mm	99 2026 702 07
8 DIN	6–8 mm	99 2062 702 08

Technische Daten / Specifications

Polzahl	4	5	6 DIN	7	8 DIN	Number of contacts
Steckverbinder Verriegelung	schrauben/screw					Connector locking system
Anschlussart	crimpen/crimp					Termination
Anschlussquerschnitt	4–6 pol. 0,14 mm <sup>2</sup> –1,0 mm <sup>2</sup> (AWG 26–AWG 18), 7+8 pol. 0,14 mm <sup>2</sup> –0,75 mm <sup>2</sup> (AWG 26–AWG 20)					Wire gauge
Kabeldurchlass	4–6 mm, 6–8 mm					Cable outlet
Schutzart	IP40					Degree of protection
Mechanische Lebensdauer	> 500 Steckzyklen/> 500 mating cycles					Mechanical operation
Obere Grenztemperatur	+ 100 °C					Upper temperature
Untere Grenztemperatur	– 40 °C					Lower temperature
Bemessungsspannung	150 V (250 V)		32 V (125 V)		32 V (60 V)	Rated voltage
Bemessungs-Stoßspannung	1500 V		500 V (800 V)		500 V	Rated impulse voltage
Verschmutzungsgrad	2 (I) <sup>1)</sup>					Pollution degree
Überspannungskategorie	II (I) <sup>1)</sup>					Overvoltage categorie
Isolierstoffgruppe	II					Material group
Bemessungsstrom (40°C)	6 A		5 A			Rated current (40 °C)
Durchgangswiderstand	≤ 5 mΩ					Contact resistance
Material Kontakt	—					Material of contact
Kontaktoberfläche	Siehe Crimpkontakte Seite 208./See crimp contacts page 208.					Contact plating
Material Kontaktkörper	PBT					Material of contact body
Material Gehäuse	CuZn (Messing, vernickelt/brass, nickel plated)					Material of housing

<sup>1)</sup> Bei Verschm.grad 1, Übersp.kat. I erhöhte Bemessungsspannung. / <sup>1)</sup> In case of pollution degree 1, overvoltage category I rated voltage is increased.

**Montageanleitung**  
Assembly instruction

**Kabelsteckverbinder, löten**  
Cable connectors, solder

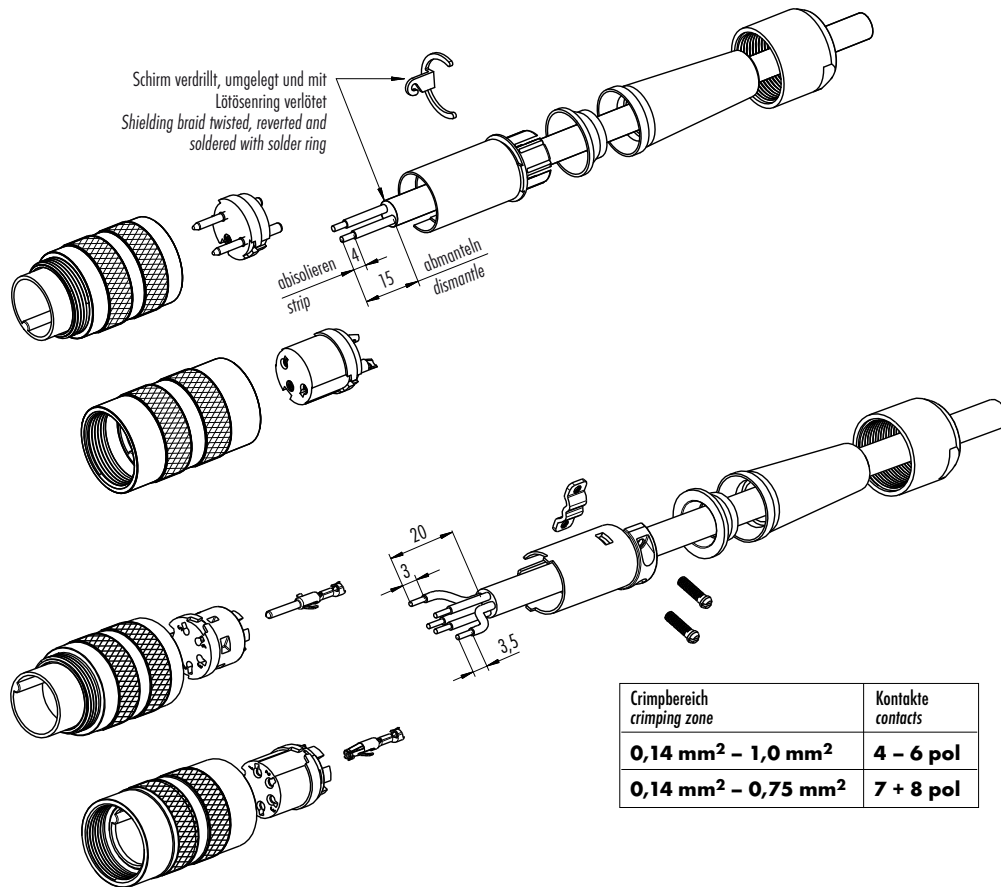

**Kabelsteckverbinder, crimpen**  
Cable connectors, crimp

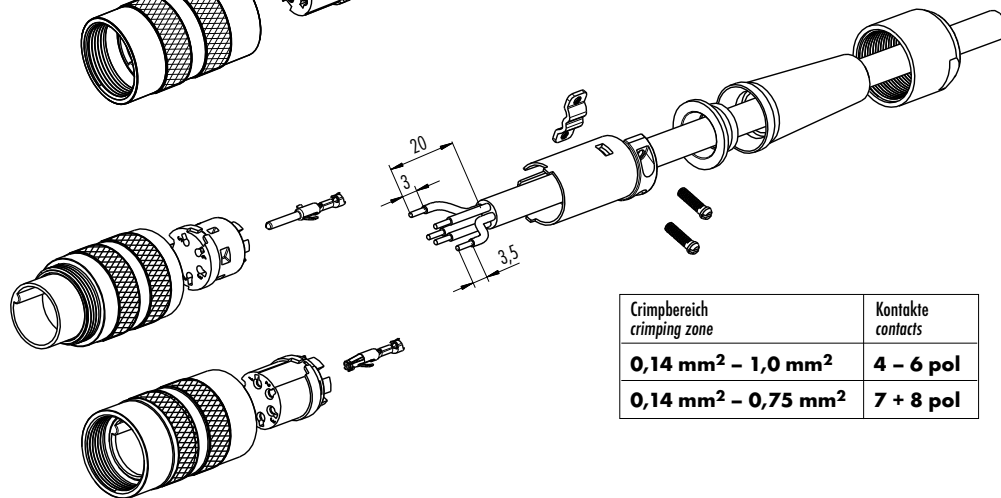

Crimpbereich crimping zone	Kontakte contacts
<b>0,14 mm<sup>2</sup> – 1,0 mm<sup>2</sup></b>	<b>4 – 6 pol</b>
<b>0,14 mm<sup>2</sup> – 0,75 mm<sup>2</sup></b>	<b>7 + 8 pol</b>

**Einzelteildarstellung**  
Component part drawing

**Kabelsteckverbinder mit Lötösenring**  
Cable connectors with solder eye ring

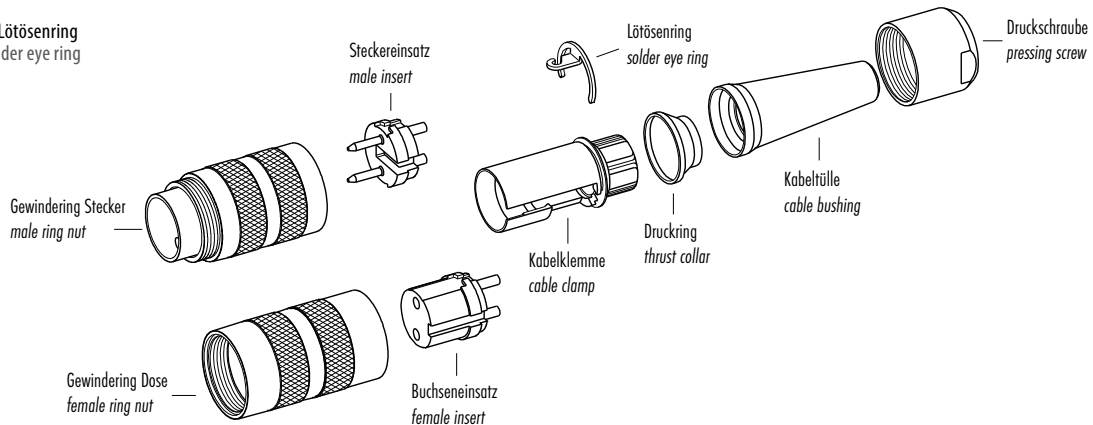

**Kabelsteckverbinder mit Kabelklemme**  
Cable connectors with cable clamp

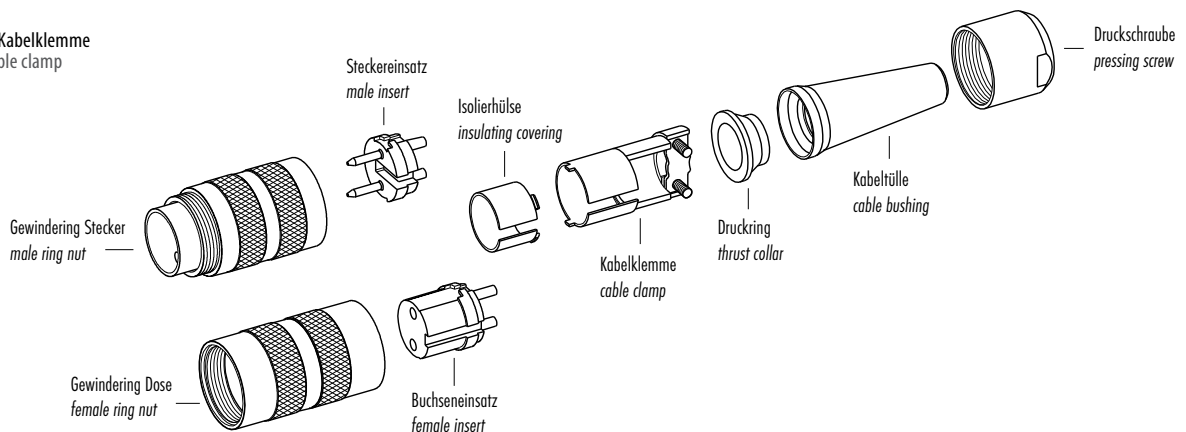

**Einzelteildarstellung**  
Component part drawing

**Kabelsteckverbinder mit Schraubklemmanschluss**  
Cable connectors with screw clamp connection

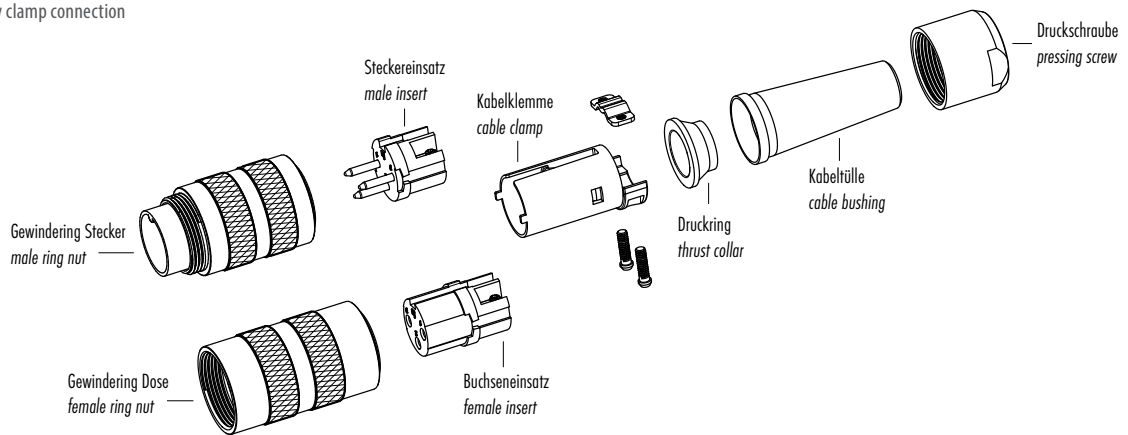

**Kabelsteckverbinder mit Crimpanschluss**  
Cable connectors with crimp connection

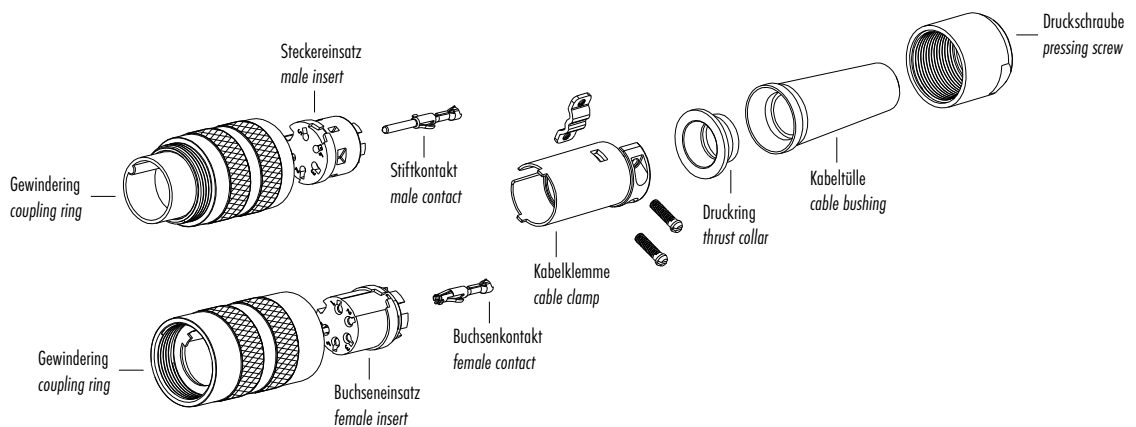

**Kennlinie**  
Rating

**Schirmdämpfungskurve nach DIN 47250-6**  
für Kabelsteckverbinder mit Kabelklemme  
(Kabeltyp IEEE 802.3)

Attenuation curve according to DIN 47250-6  
for cable connectors with cable clamp  
(cable version IEEE 802.3)

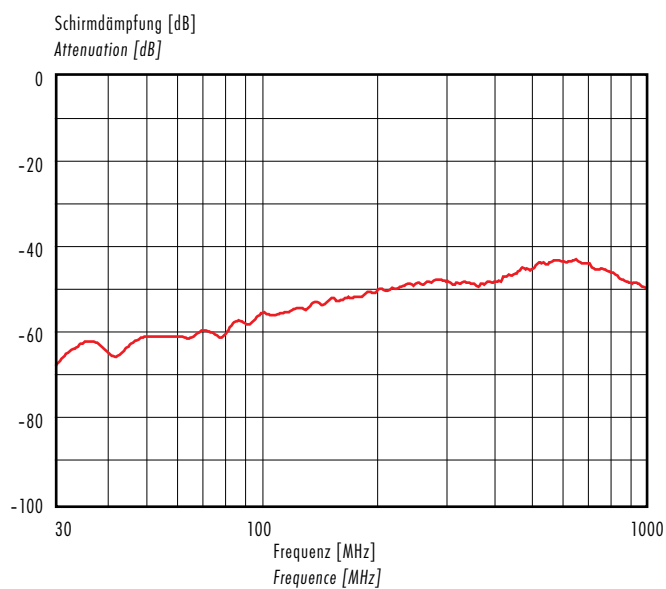

Kabelstecker  
Male cable connector

Abbildung / Figure



Kabelstecker  
Male cable connector



Maßzeichnung / Drawing

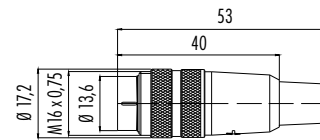
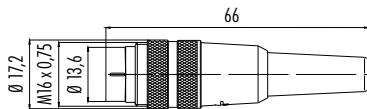

Bestell-Daten / Order Data

Polzahl Contacts	Kabeldurchlass Cable outlet	Versilberte Kontakte Silver plated contacts	Vergoldete Kontakte Gold plated contacts
2	3–6 mm	09 0301 00 02	09 0301 09 02
3 DIN	3–6 mm	09 0305 00 03	09 0305 09 03
4	3–6 mm	09 0309 00 04	09 0309 09 04
5	3–6 mm	09 0313 00 05	09 0313 09 05
5 (Stereo)	3–6 mm	09 0317 00 05	09 0317 09 05
6 DIN	3–6 mm	09 0321 00 06	09 0321 09 06
7	3–6 mm	09 0325 00 07	09 0325 09 07
7 DIN	3–6 mm	09 1581 00 07	–
8 DIN	3–6 mm	09 0571 00 08	09 0571 09 08
12	3–6 mm	–	09 0329 00 12
14	3–6 mm	–	09 0341 00 14
16	3–6 mm	–	09 0337 00 16
19	3–6 mm	–	09 0343 00 19
24	3–6 mm	–	–

Polzahl Contacts	Kabeldurchlass Cable outlet	Versilberte Kontakte Silver plated contacts	Vergoldete Kontakte Gold plated contacts
2	6–8 mm	09 0301 02 02	09 0301 92 02
3 DIN	6–8 mm	09 0305 02 03	09 0305 92 03
4	6–8 mm	09 0309 02 04	09 0309 92 04
5	6–8 mm	09 0313 02 05	09 0313 92 05
5 (Stereo)	6–8 mm	09 0317 02 05	09 0317 92 05
6 DIN	6–8 mm	09 0321 02 06	09 0321 92 06
7	6–8 mm	09 0325 02 07	09 0325 92 07
7 DIN	6–8 mm	–	–
8 DIN	6–8 mm	09 0571 02 08	09 0571 92 08
12	6–8 mm	–	09 0329 02 12
14	6–8 mm	–	09 0341 02 14
16	6–8 mm	–	09 0337 02 16
19	6–8 mm	–	09 0343 02 19
24	6–8 mm	–	09 0345 02 24

Technische Daten / Specifications

Polzahl	2	3 DIN	4	5	5 (Stereo)	6 DIN	7	7 DIN	8 DIN	12	14	16	19	24	Number of contacts
Steckverbinder Verriegelung	schrauben/screw														Connector locking system
Anschlussart	löten/solder														Termination
Anschlussquerschnitt	max. 0,75 mm <sup>2</sup> (max. AWG 18)							max. 0,25 mm <sup>2</sup> (max. AWG 24)				0,14 mm <sup>2</sup> (26)		Wire gauge	
Kabeldurchlass	3–6 mm, 6–8 mm														Cable outlet
Schutzart	IP40														Degree of protection
Mechanische Lebensdauer	> 500 Steckzyklen/> 500 mating cycles														Mechanical operation
Obere Grenztemperatur	+ 85 °C														Upper temperature
Untere Grenztemperatur	– 40 °C														Lower temperature
Bemessungsspannung	150 V (250 V)			32 V (60 V)		150 V (250 V)		32 V (125 V)		32 V (60 V)				Rated voltage	
Bemessungs-Stoßspannung	1500 V			500 V		1500 V		500 V (800 V)		500 V				Rated impulse voltage	
Verschmutzungsgrad	2 (I) <sup>1)</sup>														Pollution degree
Überspannungskategorie	II (I) <sup>1)</sup>														Overvoltage categorie
Isolierstoffgruppe	III														Material group
Bemessungsstrom (40 °C)	7 A		6 A			5 A				3 A		1 A		Rated current (40 °C)	
Durchgangswiderstand	≤ 5 mΩ														Contact resistance
Material Kontakt	CuZn (Messing/brass)														Material of contact
Kontaktoberfläche	Ag (Silber/silver)/Au (Gold/gold)							Au (Gold/gold)							Contact plating
Material Kontaktkörper	PBT														Material of contact body
Material Gehäuse	PA														Material of housing

**Kabeldose**  
Female cable connector

Abbildung / Figure



**Kabeldose**  
Female cable connector



Maßzeichnung / Drawing

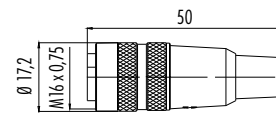
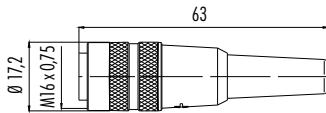

Bestell-Daten / Order Data

Polzahl Contacts	Kabeldurchlass Cable outlet	Versilberte Kontakte Silver plated contacts	Vergoldete Kontakte Gold plated contacts
2	3–6 mm	09 0302 00 02	09 0302 09 02
3 DIN	3–6 mm	09 0306 00 03	09 0306 09 03
4	3–6 mm	09 0310 00 04	09 0310 09 04
5	3–6 mm	09 0314 00 05	09 0314 09 05
5 (Stereo)	3–6 mm	09 0318 00 05	09 0318 09 05
6 DIN	3–6 mm	09 0322 00 06	09 0322 09 06
7	3–6 mm	09 0326 00 07	09 0326 09 07
7 DIN	3–6 mm	09 1582 00 07	–
8 DIN	3–6 mm	09 0572 00 08	09 0572 09 08
12	3–6 mm	–	09 0330 00 12
14	3–6 mm	–	09 0342 00 14
16	3–6 mm	–	09 0338 00 16
19	3–6 mm	–	09 0344 00 19
24	3–6 mm	–	–

Polzahl Contacts	Kabeldurchlass Cable outlet	Versilberte Kontakte Silver plated contacts	Vergoldete Kontakte Gold plated contacts
2	6–8 mm	09 0302 02 02	09 0302 92 02
3 DIN	6–8 mm	09 0306 02 03	09 0306 92 03
4	6–8 mm	09 0310 02 04	09 0310 92 04
5	6–8 mm	09 0314 02 05	09 0314 92 05
5 (Stereo)	6–8 mm	09 0318 02 05	09 0318 92 05
6 DIN	6–8 mm	09 0322 02 06	09 0322 92 06
7	6–8 mm	09 0326 02 07	09 0326 92 07
7 DIN	6–8 mm	–	–
8 DIN	6–8 mm	09 0572 02 08	09 0572 92 08
12	6–8 mm	–	09 0330 02 12
14	6–8 mm	–	09 0342 02 14
16	6–8 mm	–	09 0338 02 16
19	6–8 mm	–	09 0344 02 19
24	6–8 mm	–	09 0346 02 24

Technische Daten / Specifications

Polzahl	2	3 DIN	4	5	5 (Stereo)	6 DIN	7	7 DIN	8 DIN	12	14	16	19	24	Number of contacts
Steckverbinder Verriegelung	schrauben/screw														Connector locking system
Anschlussart	löten/solder														Termination
Anschlussquerschnitt	max. 0,75 mm <sup>2</sup> (max. AWG 18)										max. 0,25 mm <sup>2</sup> (max. AWG 24)		0,14 mm <sup>2</sup> (26)		Wire gauge
Kabeldurchlass	3–6 mm, 6–8 mm														Cable outlet
Schutzart	IP40														Degree of protection
Mechanische Lebensdauer	> 500 Steckzyklen/> 500 mating cycles														Mechanical operation
Obere Grenztemperatur	+ 85 °C														Upper temperature
Untere Grenztemperatur	– 40 °C														Lower temperature
Bemessungsspannung	150 V (250 V)				32 V (60 V)	150 V (250 V)	32 V (125 V)	32 V (60 V)						Rated voltage	
Bemessungs-Stoßspannung	1500 V				500 V	1500 V	500 V (800 V)	500 V						Rated impulse voltage	
Verschmutzungsgrad	2 (I) <sup>1)</sup>														Pollution degree
Überspannungskategorie	II (I) <sup>1)</sup>														Overvoltage categorie
Isolierstoffgruppe	III														Material group
Bemessungsstrom (40°C)	7 A		6 A				5 A				3 A		1 A		Rated current (40 °C)
Durchgangswiderstand	≤ 5 mΩ										≤ 3 mΩ				Contact resistance
Material Kontakt	CuSn (Bronze/bronze)														Material of contact
Kontaktoberfläche	Ag (Silber/silver)/Au (Gold/gold)								Au (Gold/gold)						Contact plating
Material Kontaktkörper	PBT														Material of contact body
Material Gehäuse	PA														Material of housing

<sup>1)</sup> Bei Verschm.grad 1, Übersp.kat. I erhöhte Bemessungsspannung. / <sup>1)</sup> In case of pollution degree 1, overvoltage category I rated voltage is increased.

**Einzelteildarstellung**  
Component part drawing

Kabelsteckverbinder, Kabeldurchlass 4–6 mm  
Cable connectors, cable outlet 4–6 mm

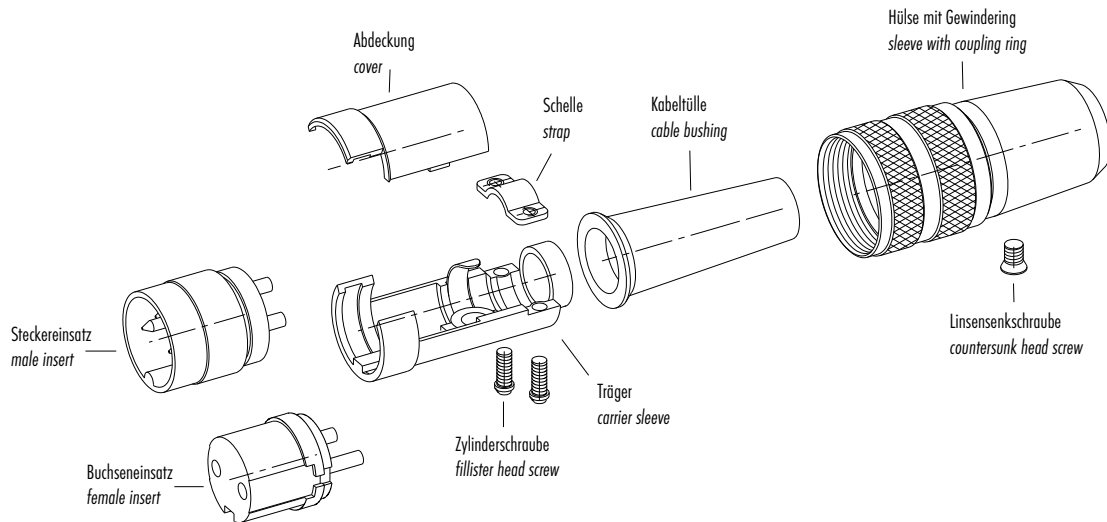

Kabelsteckverbinder, Kabeldurchlass 6–8 mm  
Cable connectors, cable outlet 6–8 mm

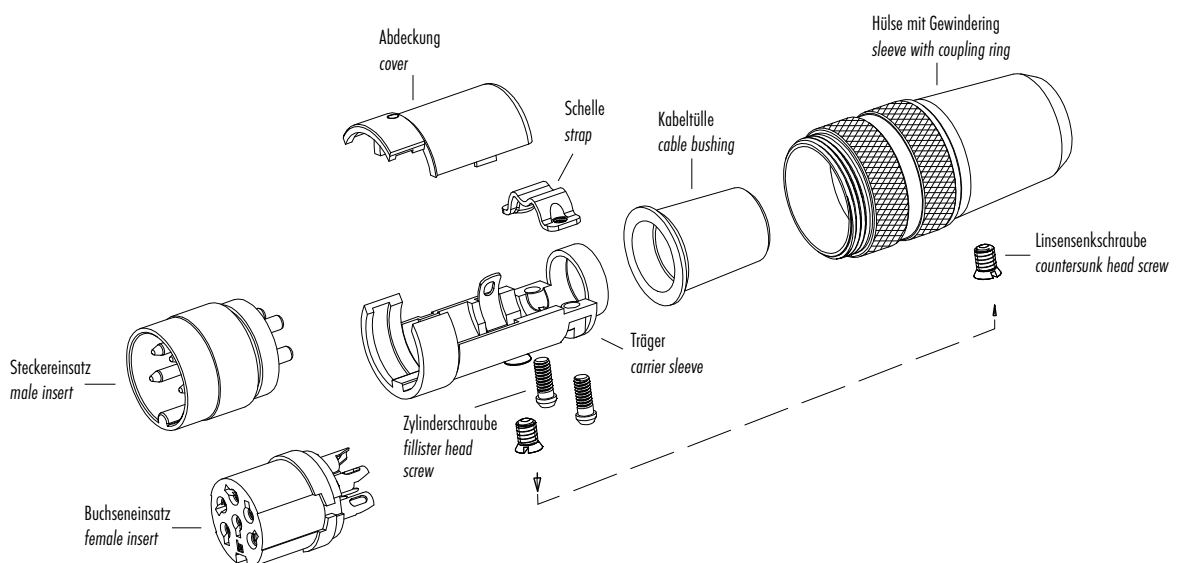



Winkelstecker, Kunststoffausführung  
Male angled connector, plastic version

Abbildung / Figure



Winkelstecker, Kunststoffausführung  
Male angled connector, plastic version



Maßzeichnung / Drawing

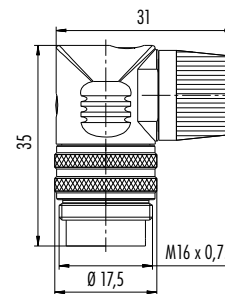
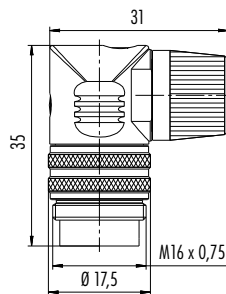

Bestell-Daten / Order Data

Polzahl Contacts	Kabeldurchlass Cable outlet	Versilberte Kontakte Silver plated contacts	Vergoldete Kontakte Gold plated contacts
2	4–6 mm	09 0133 70 02	09 0133 79 02
3 DIN	4–6 mm	09 0135 70 03	09 0135 79 03
4	4–6 mm	09 0137 70 04	09 0137 79 04
5	4–6 mm	09 0139 70 05	09 0139 79 05
5 (Stereo)	4–6 mm	09 0141 70 05	09 0141 79 05
6 DIN	4–6 mm	09 0143 70 06	09 0143 79 06
7	4–6 mm	09 0145 70 07	09 0145 79 07
7 DIN	4–6 mm	09 0177 70 07	–
8 DIN	4–6 mm	09 0153 70 08	09 0153 79 08
12	4–6 mm	–	09 0147 70 12
14	4–6 mm	–	09 0161 70 14
16	4–6 mm	–	09 0185 70 16
19	4–6 mm	–	09 0163 70 19
24	4–6 mm	–	–

Polzahl Contacts	Kabeldurchlass Cable outlet	Versilberte Kontakte Silver plated contacts	Vergoldete Kontakte Gold plated contacts
2	6–8 mm	09 0133 72 02	09 0133 78 02
3 DIN	6–8 mm	09 0135 72 03	09 0135 78 03
4	6–8 mm	09 0137 72 04	09 0137 78 04
5	6–8 mm	09 0139 72 05	09 0139 78 05
5 (Stereo)	6–8 mm	09 0141 72 05	09 0141 78 05
6 DIN	6–8 mm	09 0143 72 06	09 0143 78 06
7	6–8 mm	09 0145 72 07	09 0145 78 07
7 DIN	6–8 mm	–	–
8 DIN	6–8 mm	09 0153 72 08	09 0153 78 08
12	6–8 mm	–	09 0147 72 12
14	6–8 mm	–	09 0161 72 14
16	6–8 mm	–	09 0185 72 16
19	6–8 mm	–	09 0163 72 19
24	6–8 mm	–	09 0165 72 24

Technische Daten / Specifications

Polzahl	2	3 DIN	4	5	5 (Stereo)	6 DIN	7	7 DIN	8 DIN	12	14	16	19	24	Number of contacts
Steckverbinder Verriegelung	schrauben/screw														Connector locking system
Anschlussart	löten/solder														Termination
Anschlussquerschnitt	max. 0,75 mm <sup>2</sup> (max. AWG 18)										max. 0,25 mm <sup>2</sup> (max. AWG 24)		0,14 mm <sup>2</sup> (26)		Wire gauge
Kabeldurchlass	4–6 mm, 6–8 mm														Cable outlet
Schutzart	IP40														Degree of protection
Mechanische Lebensdauer	> 500 Steckzyklen/> 500 mating cycles														Mechanical operation
Obere Grenztemperatur	+ 85 °C														Upper temperature
Untere Grenztemperatur	– 40 °C														Lower temperature
Bemessungsspannung	150 V (250 V)				32 V (60 V)	150 V (250 V)	32 V (125 V)	32 V (60 V)						Rated voltage	
Bemessungs-Stoßspannung	1500 V				500 V	1500 V	500 V (800 V)	500 V						Rated impulse voltage	
Verschmutzungsgrad	2 (I) <sup>1)</sup>														Pollution degree
Überspannungskategorie	II (I) <sup>1)</sup>														Overvoltage categorie
Isolierstoffgruppe	III														Material group
Bemessungsstrom (40 °C)	7 A			6 A			5 A			3 A			1 A		Rated current (40 °C)
Durchgangswiderstand	≤ 5 mΩ														Contact resistance
Material Kontakt	CuZn (Messing/brass)														Material of contact
Kontaktoberfläche	Ag (Silber/silver)/Au (Gold/gold)									Au (Gold/gold)					Contact plating
Material Kontaktkörper	PBT														Material of contact body
Material Gehäuse	PA														Material of housing



**Winkelstecker, Metallausführung, schirmbar**  
Male angled connector, metal version, shieldable

Abbildung / Figure



**Winkelstecker, Metallausführung, schirmbar**  
Male angled connector, metal version, shieldable



Maßzeichnung / Drawing

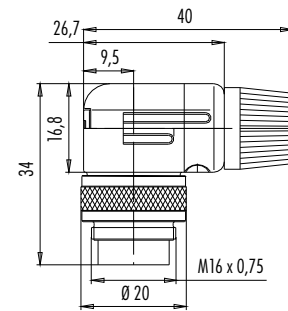
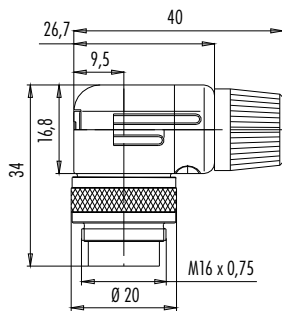

Bestell-Daten / Order Data

Polzahl Contacts	Kabeldurchlass Cable outlet	Versilberte Kontakte Silver plated contacts	Vergoldete Kontakte Gold plated contacts
2	4–6 mm	99 0133 10 02	–
3 DIN	4–6 mm	99 0135 10 03	–
4	4–6 mm	99 0137 10 04	–
5	4–6 mm	99 0139 10 05	–
5 (Stereo)	4–6 mm	99 0141 10 05	–
6 DIN	4–6 mm	99 0143 10 06	–
7	4–6 mm	99 0145 10 07	–
7 DIN	4–6 mm	99 0177 10 07	–
8 DIN	4–6 mm	99 0153 10 08	–
12	4–6 mm	–	99 0147 10 12
14	4–6 mm	–	99 0161 10 14
19	4–6 mm	–	99 0163 10 19
24	4–6 mm	–	–

Polzahl Contacts	Kabeldurchlass Cable outlet	Versilberte Kontakte Silver plated contacts	Vergoldete Kontakte Gold plated contacts
2	6–8 mm	99 0133 12 02	–
3 DIN	6–8 mm	99 0135 12 03	–
4	6–8 mm	99 0137 12 04	–
5	6–8 mm	99 0139 12 05	–
5 (Stereo)	6–8 mm	99 0141 12 05	–
6 DIN	6–8 mm	99 0143 12 06	–
7	6–8 mm	99 0145 12 07	–
7 DIN	6–8 mm	–	–
8 DIN	6–8 mm	99 0153 12 08	–
12	6–8 mm	–	99 0147 12 12
14	6–8 mm	–	99 0161 12 14
19	6–8 mm	–	99 0163 12 19
24	6–8 mm	–	99 0165 12 24

Technische Daten / Specifications

Polzahl	2	3 DIN	4	5	5 (Stereo)	6 DIN	7	7 DIN	8 DIN	12	14	19	24	Number of contacts
Steckverbinder Verriegelung	schrauben/screw													Connector locking system
Anschlussart	löten/solder													Termination
Anschlussquerschnitt	max. 0,75 mm <sup>2</sup> (max. AWG 18)									max. 0,25 mm <sup>2</sup> (max. AWG 24)		0,14 mm <sup>2</sup> (26)		Wire gauge
Kabeldurchlass	4–6 mm, 6–8 mm													Cable outlet
Schutzart	IP40													Degree of protection
Mechanische Lebensdauer	> 500 Steckzyklen/> 500 mating cycles													Mechanical operation
Obere Grenztemperatur	+ 85 °C													Upper temperature
Untere Grenztemperatur	– 40 °C													Lower temperature
Bemessungsspannung	150 V (250 V)			32 V (60 V)		150 V (250 V)		32 V (125 V)		32 V (60 V)				Rated voltage
Bemessungs-Stoßspannung	1500 V			500 V		1500 V		500 V (800 V)		500 V				Rated impulse voltage
Verschmutzungsgrad	2 (I) <sup>1)</sup>													Pollution degree
Überspannungskategorie	II (I) <sup>1)</sup>													Overvoltage categorie
Isolierstoffgruppe	III													Material group
Bemessungsstrom (40°C)	7 A		6 A			5 A				3 A		1 A		Rated current (40 °C)
Durchgangswiderstand	≤ 5 mΩ									≤ 3 mΩ				Contact resistance
Material Kontakt	CuZn (Messing/brass)													Material of contact
Kontaktfläche	Ag (Silber/silver)/Au (Gold/gold)									Au (Gold/gold)				Contact plating
Material Kontaktkörper	PBT													Material of contact body
Material Gehäuse	PA													Material of housing

<sup>1)</sup> Bei Verschm.grad 1, Übersp.kat. I erhöhte Bemessungsspannung. / <sup>1)</sup> In case of pollution degree 1, overvoltage category I rated voltage is increased.

Winkeldose, Kunststoffausführung  
Female angled connector, plastic version

Winkeldose, Kunststoffausführung  
Female angled connector, plastic version

Abbildung / Figure



Maßzeichnung / Drawing

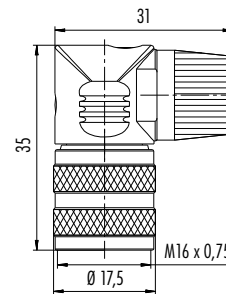
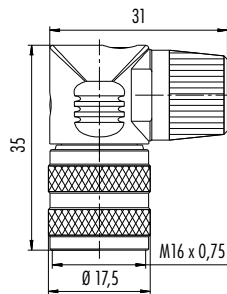

Bestell-Daten / Order Data

Polzahl Contacts	Kabeldurchlass Cable outlet	Versilberte Kontakte Silver plated contacts	Vergoldete Kontakte Gold plated contacts
2	4–6 mm	09 0134 70 02	–
3 DIN	4–6 mm	09 0136 70 03	09 0136 79 03
4	4–6 mm	09 0138 70 04	09 0138 79 04
5	4–6 mm	09 0140 70 05	09 0140 79 05
5 (Stereo)	4–6 mm	09 0142 70 05	09 0142 79 05
6 DIN	4–6 mm	09 0144 70 06	09 0144 79 06
7	4–6 mm	09 0146 70 07	09 0146 79 07
7 DIN	4–6 mm	09 0178 70 07	–
8 DIN	4–6 mm	09 0154 70 08	09 0154 79 08
12	4–6 mm	–	09 0148 70 12
14	4–6 mm	–	09 0162 70 14
16	4–6 mm	–	09 0186 70 16
19	4–6 mm	–	09 0164 70 19
24	4–6 mm	–	–

Polzahl Contacts	Kabeldurchlass Cable outlet	Versilberte Kontakte Silver plated contacts	Vergoldete Kontakte Gold plated contacts
2	6–8 mm	09 0134 72 02	–
3 DIN	6–8 mm	09 0136 72 03	09 0136 78 03
4	6–8 mm	09 0138 72 04	09 0138 78 04
5	6–8 mm	09 0140 72 05	09 0140 78 05
5 (Stereo)	6–8 mm	09 0142 72 05	–
6 DIN	6–8 mm	09 0144 72 06	09 0144 78 06
7	6–8 mm	09 0146 72 07	09 0146 78 07
7 DIN	6–8 mm	–	–
8 DIN	6–8 mm	09 0154 72 08	09 0154 78 08
12	6–8 mm	–	09 0148 72 12
14	6–8 mm	–	09 0162 72 14
16	6–8 mm	–	09 0186 72 16
19	6–8 mm	–	09 0164 72 19
24	6–8 mm	–	09 0166 72 24

Technische Daten / Specifications

Polzahl	2	3 DIN	4	5	5 (Stereo)	6 DIN	7	7 DIN	8 DIN	12	14	16	19	24	Number of contacts	
Steckverbinder Verriegelung	schrauben/screw														Connector locking system	
Anschlussart	löten/solder														Termination	
Anschlussquerschnitt	max. 0,75 mm <sup>2</sup> (max. AWG 18)										max. 0,25 mm <sup>2</sup> (max. AWG 24)		0,14 mm <sup>2</sup> (26)		Wire gauge	
Kabeldurchlass	4–6 mm, 6–8 mm														Cable outlet	
Schutzart	IP40														Degree of protection	
Mechanische Lebensdauer	> 500 Steckzyklen/> 500 mating cycles														Mechanical operation	
Obere Grenztemperatur	+ 85 °C														Upper temperature	
Untere Grenztemperatur	– 40 °C														Lower temperature	
Bemessungsspannung	150 V (250 V)				32 V (60 V)	150 V (250 V)	32 V (125 V)	32 V (60 V)							Rated voltage	
Bemessungs-Stoßspannung	1500 V				500 V	1500 V	500 V (800 V)	500 V							Rated impulse voltage	
Verschmutzungsgrad	2 (I) <sup>1)</sup>														Pollution degree	
Überspannungskategorie	II (I) <sup>1)</sup>														Overvoltage categorie	
Isolierstoffgruppe	III														Material group	
Bemessungsstrom (40 °C)	7 A			6 A			5 A					3 A		1 A		Rated current (40 °C)
Durchgangswiderstand	≤ 5 mΩ														≤ 3 mΩ	Contact resistance
Material Kontakt	CuSn (Bronze/bronze)														Material of contact	
Kontaktoberfläche	Ag (Silber/silver)/Au (Gold/gold)									Au (Gold/gold)					Contact plating	
Material Kontaktkörper	PBT														Material of contact body	
Material Gehäuse	PA														Material of housing	

**Winkeldose, Metallausführung, schirmbar**  
Female angled connector, metal version, shieldable

Abbildung / Figure



**Winkeldose, Metallausführung, schirmbar**  
Female angled connector, metal version, shieldable



Maßzeichnung / Drawing

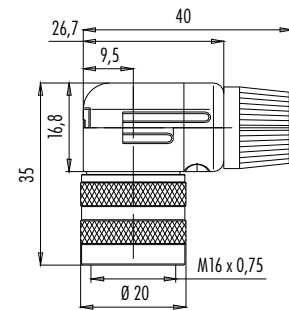
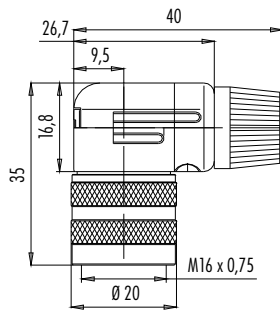

Bestell-Daten / Order Data

Polzahl Contacts	Kabeldurchlass Cable outlet	Versilberte Kontakte Silver plated contacts	Vergoldete Kontakte Gold plated contacts
2	4–6 mm	99 0134 10 02	–
3 DIN	4–6 mm	99 0136 10 03	–
4	4–6 mm	99 0138 10 04	–
5	4–6 mm	99 0140 10 05	–
5 (Stereo)	4–6 mm	99 0142 10 05	–
6 DIN	4–6 mm	99 0144 10 06	–
7	4–6 mm	99 0146 10 07	–
7 DIN	4–6 mm	–	–
8 DIN	4–6 mm	99 0154 10 08	–
12	4–6 mm	–	99 0148 10 12
14	4–6 mm	–	99 0162 10 14
19	4–6 mm	–	99 0164 10 19
24	4–6 mm	–	–

Polzahl Contacts	Kabeldurchlass Cable outlet	Versilberte Kontakte Silver plated contacts	Vergoldete Kontakte Gold plated contacts
2	6–8 mm	99 0134 12 02	–
3 DIN	6–8 mm	99 0136 12 03	–
4	6–8 mm	99 0138 12 04	–
5	6–8 mm	99 0140 12 05	–
5 (Stereo)	6–8 mm	99 0142 12 05	–
6 DIN	6–8 mm	99 0144 12 06	–
7	6–8 mm	99 0146 12 07	–
7 DIN	6–8 mm	–	–
8 DIN	6–8 mm	99 0154 12 08	–
12	6–8 mm	–	99 0148 12 12
14	6–8 mm	–	99 0162 12 14
19	6–8 mm	–	99 0164 12 19
24	6–8 mm	–	99 0166 12 24

Technische Daten / Specifications

Polzahl	2	3 DIN	4	5	5 (Stereo)	6 DIN	7	7 DIN	8 DIN	12	14	19	24	Number of contacts		
Steckverbinder Verriegelung	schrauben/screw													Connector locking system		
Anschlussart	löten/solder													Termination		
Anschlussquerschnitt	max. 0,75 mm <sup>2</sup> (max. AWG 18)													max. 0,25 mm <sup>2</sup> (max. AWG 24)	0,14 mm <sup>2</sup> (26)	Wire gauge
Kabeldurchlass	4–6 mm, 6–8 mm													Cable outlet		
Schutzart	IP40													Degree of protection		
Mechanische Lebensdauer	> 500 Steckzyklen/> 500 mating cycles													Mechanical operation		
Obere Grenztemperatur	+ 85 °C													Upper temperature		
Untere Grenztemperatur	– 40 °C													Lower temperature		
Bemessungsspannung	150 V (250 V)			32 V (60 V)		150 V (250 V)		32 V (125 V)		32 V (60 V)				Rated voltage		
Bemessungs-Stoßspannung	1500 V			500 V		1500 V		500 V (800 V)		500 V				Rated impulse voltage		
Verschmutzungsgrad	2 (1) <sup>1)</sup>													Pollution degree		
Überspannungskategorie	II (I) <sup>1)</sup>													Overvoltage categorie		
Isolierstoffgruppe	III													Material group		
Bemessungsstrom (40°C)	7 A		6 A			5 A				3 A		1 A		Rated current (40 °C)		
Durchgangswiderstand	≤ 5 mΩ													≤ 3 mΩ	Contact resistance	
Material Kontakt	CuSn (Bronze/bronze)													Material of contact		
Kontaktfläche	Ag (Silber/silver)/Au (Gold/gold)									Au (Gold/gold)				Contact plating		
Material Kontaktkörper	PBT													Material of contact body		
Material Gehäuse	PA													Material of housing		

<sup>1)</sup> Bei Verschm.grad 1, Übersp.kat. I erhöhte Bemessungsspannung. / <sup>1)</sup> In case of pollution degree 1, overvoltage category I rated voltage is increased.

Einzelteildarstellung  
Component part drawing

Winkelsteckverbinder, Kunststoffausführung  
Angled connectors, plastic version

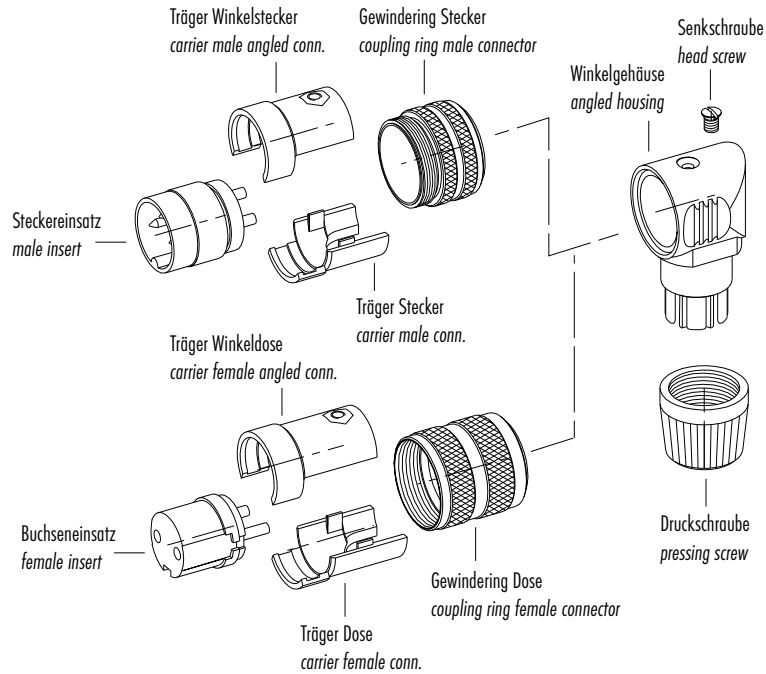

Winkelsteckverbinder, Metallausführung  
Angled connectors, metal version

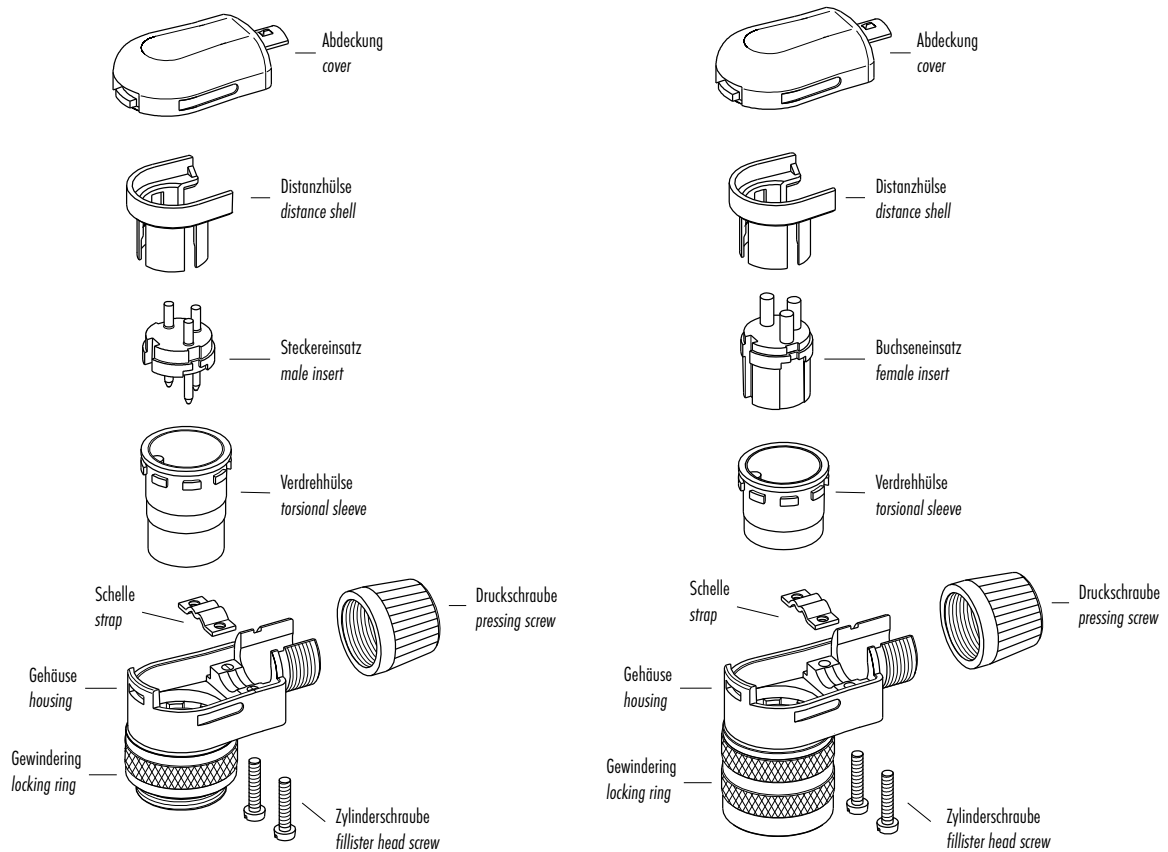



**Flanschstecker, löten**  
Male panel mount connector, solder

Abbildung / Figure



**Flanschstecker, löten, von vorn verschraubbar**  
Male panel mount connector, solder, front fastened



Maßzeichnung / Drawing

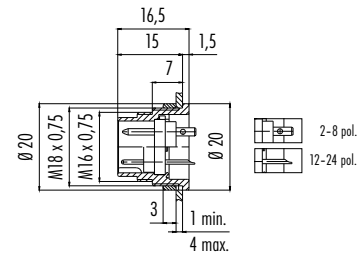
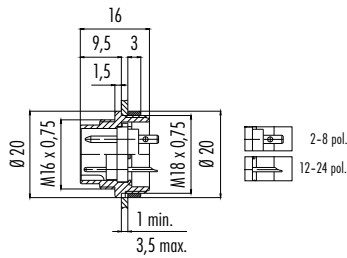

Bestell-Daten / Order Data

Polzahl Contacts	Versilberte Kontakte Silver plated contacts	Vergoldete Kontakte Gold plated contacts
2	09 0303 00 02	09 0303 09 02
3 DIN	09 0307 00 03	09 0307 09 03
4	09 0311 00 04	09 0311 09 04
5	09 0315 00 05	09 0315 09 05
5 (Stereo)	09 0319 00 05	09 0319 09 05
6 DIN	09 0323 00 06	09 0323 09 06
7	09 0327 00 07	09 0327 09 07
7 DIN	09 1583 00 07	—
8 DIN	09 0473 00 08	09 0473 09 08
12	—	09 0331 00 12
14	—	09 0053 00 14
16	—	09 0339 00 16
19	—	09 0335 00 19
24	—	09 0197 00 24

Polzahl Contacts	Versilberte Kontakte Silver plated contacts	Vergoldete Kontakte Gold plated contacts
2	09 0303 80 02	09 0303 89 02
3 DIN	09 0307 80 03	09 0307 89 03
4	09 0311 80 04	09 0311 89 04
5	09 0315 80 05	09 0315 89 05
5 (Stereo)	09 0319 80 05	—
6 DIN	09 0323 80 06	09 0323 89 06
7	09 0327 80 07	09 0327 89 07
7 DIN	—	—
8 DIN	09 0473 80 08	09 0473 89 08
12	—	09 0331 80 12
14	—	09 0053 80 14
16	—	09 0339 80 16
19	—	09 0335 80 19
24	—	09 0197 80 24

Technische Daten / Specifications

Polzahl	2	3 DIN	4	5	5 (Stereo)	6 DIN	7	7 DIN	8 DIN	12	14	16	19	24	Number of contacts	
Steckverbinder Verriegelung	schrauben/screw														Connector locking system	
Anschlussart	löten/solder														Termination	
Anschlussquerschnitt	max. 0,75 mm <sup>2</sup> (max. AWG 18)										max. 0,25 mm <sup>2</sup> (max. AWG 24)			0,14 mm <sup>2</sup> (26)	Wire gauge	
Kabeldurchlass	—														Cable outlet	
Schutzart	IP40														Degree of protection	
Mechanische Lebensdauer	> 500 Steckzyklen/> 500 mating cycles														Mechanical operation	
Obere Grenztemperatur	+ 85 °C														Upper temperature	
Untere Grenztemperatur	- 40 °C														Lower temperature	
Bemessungsspannung	150 V (250 V)			32 V (60 V)	150 V (250 V)	32 V (125 V)	32 V (60 V)						Rated voltage			
Bemessungs-Stoßspannung	1500 V			500 V	1500 V	500 V (800 V)	500 V						Rated impulse voltage			
Verschmutzungsgrad	2 (I) <sup>1)</sup>														Pollution degree	
Überspannungskategorie	II (I) <sup>1)</sup>														Overvoltage categorie	
Isolierstoffgruppe	III														Material group	
Bemessungsstrom (40 °C)	7 A			6 A			5 A			3 A			1 A		Rated current (40 °C)	
Durchgangswiderstand	≤ 5 mΩ														≤ 3 mΩ	Contact resistance
Material Kontakt	CuZn (Messing/brass)														Material of contact	
Kontaktoberfläche	Ag (Silber/silver)/Au (Gold/gold)									Au (Gold/gold)						Contact plating
Material Kontaktkörper	PBT														Material of contact body	
Material Gehäuse	Zink Druckguss vernickelt/zinc diecasting nickel plated														Material of housing	

Flanschstecker, tauchlöten, von vorn verschraubbar  
Male panel mount connector, dip solder, front fastened

Abbildung / Figure



Flanschstecker, tauchlöten, von vorn verschraubbar, mit Schirmanbindung  
Male panel mount connector, dip solder, front fastened, with shield connection



Bohrbilder siehe Seite 207  
Drilling schemes see page 207

Maßzeichnung / Drawing

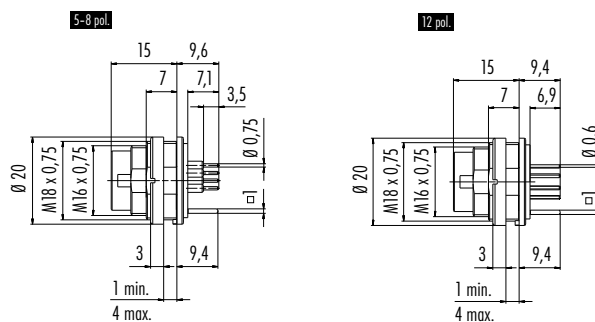
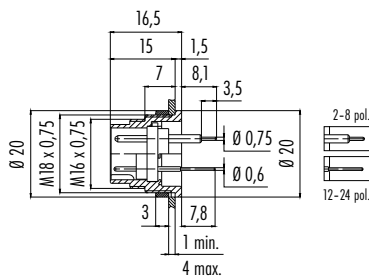

Bestell-Daten / Order Data

Polzahl Contacts	Versilberte Kontakte Silver plated contacts	Vergoldete Kontakte Gold plated contacts
2	09 0303 90 02	09 0303 99 02
3 DIN	09 0307 90 03	09 0307 99 03
4	09 0311 90 04	09 0311 99 04
5	09 0315 90 05	09 0315 99 05
5 (Stereo)	09 0319 90 05	09 0319 99 05
6 DIN	09 0323 90 06	09 0323 99 06
7	09 0327 90 07	09 0327 99 07
7 DIN	—	—
8 DIN	09 0473 90 08	—
12	—	09 0331 90 12
14	—	09 0053 90 14
16	—	09 0339 90 16
19	—	09 0335 90 19
24	—	09 0197 90 24

Polzahl Contacts	Versilberte Kontakte Silver plated contacts	Vergoldete Kontakte Gold plated contacts
5	09 0315 290 05	—
6 DIN	09 0323 290 06	—
8 DIN	09 0473 290 08	—
12	—	09 0331 290 12

Technische Daten / Specifications

Polzahl	2	3 DIN	4	5	5 (Stereo)	6 DIN	7	7 DIN	8 DIN	12	14	16	19	24	Number of contacts	
Steckverbinder Verriegelung	schrauben/screw														Connector locking system	
Anschlussart	tauchlöten/dip solder														Termination	
Anschlussquerschnitt	—														Wire gauge	
Kabeldurchlass	—														Cable outlet	
Schutzart	IP40														Degree of protection	
Mechanische Lebensdauer	> 500 Steckzyklen/> 500 mating cycles														Mechanical operation	
Obere Grenztemperatur	+ 85 °C														Upper temperature	
Untere Grenztemperatur	- 40 °C														Lower temperature	
Bemessungsspannung	150 V (250 V)			32 V (60 V)			150 V (250 V)			32 V (125 V)			32 V (60 V)			Rated voltage
Bemessungs-Stoßspannung	1500 V			500 V			1500 V			500 V (800 V)			500 V			Rated impulse voltage
Verschmutzungsgrad	2 (1) <sup>1)</sup>														Pollution degree	
Überspannungskategorie	II (I) <sup>1)</sup>														Overvoltage categorie	
Isolierstoffgruppe	III														Material group	
Bemessungsstrom (40°C)	7 A			6 A			5 A			3 A			1 A			Rated current (40 °C)
Durchgangswiderstand	≤ 5 mΩ														≤ 3 mΩ	Contact resistance
Material Kontakt	CuZn (Messing/brass)														Material of contact	
Kontaktoberfläche	Ag (Silber/silver)/Au (Gold/gold)						Au (Gold/gold)								Contact plating	
Material Kontaktkörper	PBT														Material of contact body	
Material Gehäuse	Zink Druckguss vernickelt/zinc diecasting nickel plated, CuZn (Messing, vernickelt/brass, nickel plated)														Material of housing	

<sup>1)</sup> Bei Verschm.grad 1, Übersp.kat. I erhöhte Bemessungsspannung. / <sup>1)</sup> In case of pollution degree 1, overvoltage category I rated voltage is increased.

**Flanschstecker, crimpen**  
Male panel mount connector, crimp

Abbildung / Figure



Crimp- und Bandkontakte siehe Seite 208  
Crimp and strip contacts see page 208

Maßzeichnung / Drawing

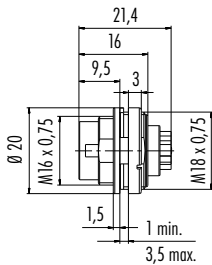

Bestell-Daten / Order Data

Polzahl Contacts	Bestell-Nr. Ordering-No.
4	09 0311 700 04
5	09 0315 700 05
6 DIN	09 0323 700 06
7	09 0327 700 07
8 DIN	09 0473 700 08

**Flanschstecker, crimpen, von vorn verschraubbar**  
Male panel mount connector, crimp, front fastened



Crimp- und Bandkontakte siehe Seite 208  
Crimp and strip contacts see page 208

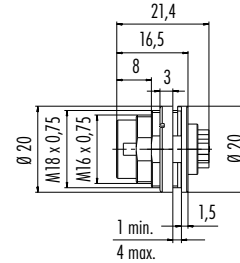

Polzahl Contacts	Bestell-Nr. Ordering-No.
4	09 0311 780 04
5	09 0315 780 05
6 DIN	09 0323 780 06
7	09 0327 780 07
8 DIN	09 0473 780 08

Technische Daten / Specifications

Polzahl	4	5	6 DIN	7	8 DIN	Number of contacts
Steckverbinder Verriegelung	schrauben/screw					Connector locking system
Anschlussart	crimpen/crimp					Termination
Anschlussquerschnitt	4–6 pol. 0,14 mm <sup>2</sup> –1,0 mm <sup>2</sup> (AWG 26–AWG 18), 7+8 pol. 0,14 mm <sup>2</sup> –0,75 mm <sup>2</sup> (AWG 26–AWG 20)					Wire gauge
Kabeldurchlass	—					Cable outlet
Schutzart	IP40					Degree of protection
Mechanische Lebensdauer	> 500 Steckzyklen/> 500 mating cycles					Mechanical operation
Obere Grenztemperatur	+ 100 °C					Upper temperature
Untere Grenztemperatur	– 40 °C					Lower temperature
Bemessungsspannung	150 V (250 V)		32 V (125 V)		32 V (60 V)	Rated voltage
Bemessungs-Stoßspannung	1500 V		500 V (800 V)		500 V	Rated impulse voltage
Verschmutzungsgrad	2 (I) <sup>1)</sup>					Pollution degree
Überspannungskategorie	II (I) <sup>1)</sup>					Overvoltage categorie
Isolierstoffgruppe	II					Material group
Bemessungsstrom (40 °C)	6 A		5 A			Rated current (40 °C)
Durchgangswiderstand	≤ 5 mΩ					Contact resistance
Material Kontakt	—					Material of contact
Kontaktoberfläche	Siehe Crimpkontakte Seite 208./See crimp contacts page 208.					Contact plating
Material Kontaktkörper	PBT					Material of contact body
Material Gehäuse	CuZn (Messing, vernickelt/brass, nickel plated)					Material of housing



Flanschstecker mit Litzen (200 mm), AWG 22

Male panel mount connector, with single wires (200 mm), AWG 22

Abbildung / Figure



Flanschstecker, von vorn verschraubbar, mit Litzen (200 mm), AWG 22

Male panel mount connector, front fastened, with single wires (200 mm), AWG 22



Maßzeichnung / Drawing

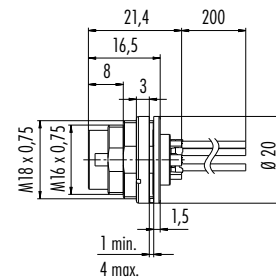
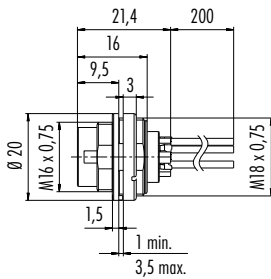

Bestell-Daten / Order Data

Polzahl Contacts	Bestell-Nr. Ordering-No.
4	09 0311 702 04
5	09 0315 702 05
6 DIN	09 0323 702 06
7	09 0327 702 07
8 DIN	09 0473 702 08

Polzahl Contacts	Bestell-Nr. Ordering-No.
4	09 0311 782 04
5	09 0315 782 05
6 DIN	09 0323 782 06
7	09 0327 782 07
8 DIN	09 0473 782 08

Technische Daten / Specifications

Polzahl	4	5	6 DIN	7	8 DIN	Number of contacts
Steckverbinder Verriegelung	schrauben/screw					Connector locking system
Anschlussart	Litzen/single wires					Termination
Anschlussquerschnitt	AWG 22/7 (0,35 mm <sup>2</sup> )					Wire gauge
Kabeldurchlass	—					Cable outlet
Schutzart	IP40					Degree of protection
Mechanische Lebensdauer	> 500 Steckzyklen/> 500 mating cycles					Mechanical operation
Obere Grenztemperatur	+ 100 °C					Upper temperature
Untere Grenztemperatur	- 40 °C					Lower temperature
Bemessungsspannung	150 V (250 V)		32 V (125 V)		32 V (60 V)	Rated voltage
Bemessungs-Stoßspannung	1500 V		500 V (800 V)		500 V	Rated impulse voltage
Verschmutzungsgrad	2 (I) <sup>1)</sup>					Pollution degree
Überspannungskategorie	II (I) <sup>1)</sup>					Overvoltage categorie
Isolierstoffgruppe	III					Material group
Bemessungsstrom (40 °C)	6 A		5 A			Rated current (40 °C)
Durchgangswiderstand	≤ 5 mΩ					Contact resistance
Material Kontakt	CuSn (Bronze/bronze)					Material of contact
Kontaktoberfläche	Ag (Silber/silver)					Contact plating
Material Kontaktkörper	PBT					Material of contact body
Material Gehäuse	CuZn (Messing, vernickelt/brass, nickel plated)					Material of housing

<sup>1)</sup> Bei Verschm.grad 1, Übersp.kat. I erhöhte Bemessungsspannung. / <sup>1)</sup> In case of pollution degree 1, overvoltage category I rated voltage is increased.

Flanschstecker mit flexibler Leiterplatte, von vorn verschraubbar  
Male panel mount connector with flexible PCB, front fastened

Flanschstecker mit flexibler Leiterplatte, von vorn verschraubbar  
Male panel mount connector with flexible PCB, front fastened

Abbildung / Figure



Maßzeichnung / Drawing

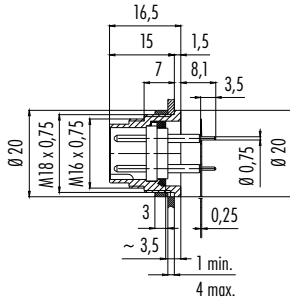

einreihig / single-row

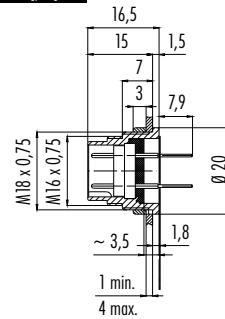

doppelreihig / double-row

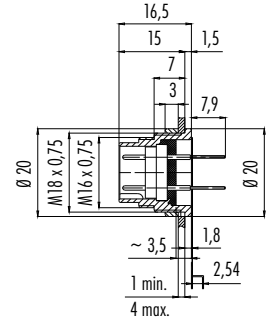

Bestell-Daten / Order Data

Polzahl Contacts	Versilberte Kontakte Silver plated contacts	Vergoldete Kontakte Gold plated contacts
7	09 0327 65 07	-
8 DIN	09 0473 65 08	-

Polzahl Contacts	Einreihig - vergoldete Kontakte Single row - gold plated contacts	Doppelreihig - vergoldete Kontakte Double row - gold plated contacts
12	09 0331 65 12	09 0331 66 12

Technische Daten / Specifications

Polzahl	7	8 DIN	12	Number of contacts
Steckverbinder Verriegelung		schrauben/screw		Connector locking system
Anschlussart		tauchlöten/dip solder		Termination
Anschlussquerschnitt		—		Wire gauge
Kabeldurchlass		—		Cable outlet
Schutzart		IP40		Degree of protection
Mechanische Lebensdauer		> 500 Steckzyklen/> 500 mating cycles		Mechanical operation
Obere Grenztemperatur		+ 85 °C		Upper temperature
Untere Grenztemperatur		- 40 °C		Lower temperature
Bemessungsspannung	32 V (125 V)		632 V (60 V)	Rated voltage
Bemessungs-Stoßspannung	500 V (800 V)		500 V	Rated impulse voltage
Verschmutzungsgrad		2 (I) <sup>1)</sup>		Pollution degree
Überspannungskategorie		II (I) <sup>1)</sup>		Overvoltage categorie
Isolierstoffgruppe		III		Material group
Bemessungsstrom (40 °C)		5 A	3 A	Rated current (40 °C)
Durchgangswiderstand		≤ 5 mΩ	≤ 3 mΩ	Contact resistance
Material Kontakt		CuZn (Messing/brass)		Material of contact
Kontaktoberfläche		Ag (Silber/silver)	Au (Gold/gold)	Contact plating
Material Kontaktkörper		PBT		Material of contact body
Material Gehäuse		Zink Druckguss vernickelt/zinc diecasting nickel plated		Material of housing

**Flanschdose, löten**  
Female panel mount connector, solder

Abbildung / Figure



**Flanschdose, löten**  
Female panel mount connector, solder



Maßzeichnung / Drawing

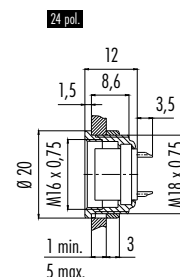
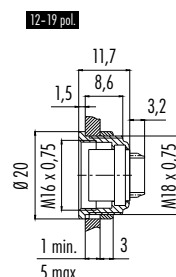
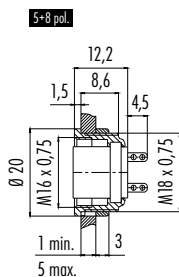
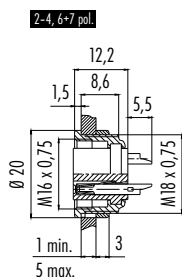

Bestell-Daten / Order Data

Polzahl Contacts	Versilberte Kontakte Silver plated contacts	Vergoldete Kontakte Gold plated contacts
2	09 0304 00 02	09 0304 09 02
3 DIN	09 0308 00 03	09 0308 09 03
4	09 0312 00 04	09 0312 09 04
5	09 0316 00 05	09 0316 09 05
5 (Stereo)	09 0320 00 05	09 0320 09 05
6 DIN	09 0324 00 06	09 0324 09 06
7	09 0328 00 07	09 0328 09 07
7 DIN	09 1584 00 07	—
8 DIN	09 0474 00 08	09 0474 09 08

Polzahl Contacts	Versilberte Kontakte Silver plated contacts	Vergoldete Kontakte Gold plated contacts
12	—	09 0332 00 12
14	—	09 0054 00 14
16	—	09 0340 00 16
19	—	09 0336 00 19
24	—	09 0198 00 24

Technische Daten / Specifications

Polzahl	2	3 DIN	4	5	5 (Stereo)	6 DIN	7	7 DIN	8 DIN	12	14	16	19	24	Number of contacts	
Steckverbinder Verriegelung	schrauben/screw														Connector locking system	
Anschlussart	löten/solder														Termination	
Anschlussquerschnitt	max. 0,75 mm <sup>2</sup> (max. AWG 18)														Wire gauge	
Kabeldurchlass	—														Cable outlet	
Schutzart	IP40														Degree of protection	
Mechanische Lebensdauer	> 500 Steckzyklen/> 500 mating cycles														Mechanical operation	
Obere Grenztemperatur	+ 85 °C														Upper temperature	
Untere Grenztemperatur	- 40 °C														Lower temperature	
Bemessungsspannung	150 V (250 V)			32 V (60 V)			150 V (250 V)			32 V (125 V)			32 V (60 V)			Rated voltage
Bemessungs-Stoßspannung	1500 V			500 V			1500 V			500 V (800 V)			500 V			Rated impulse voltage
Verschmutzungsgrad	2 (1) <sup>1)</sup>														Pollution degree	
Überspannungskategorie	II (I) <sup>1)</sup>														Overvoltage categorie	
Isolierstoffgruppe	III														Material group	
Bemessungsstrom (40°C)	7 A			6 A			5 A			3 A			1 A			Rated current (40 °C)
Durchgangswiderstand	≤ 5 mΩ														Contact resistance	
Material Kontakt	CuSn (Bronze/bronze)														Material of contact	
Kontaktoberfläche	Ag (Silber/silver)/Au (Gold/gold)														Contact plating	
Material Kontaktkörper	PBT														Material of contact body	
Material Gehäuse	Zink Druckguss vernickelt/zinc diecasting nickel plated														Material of housing	

<sup>1)</sup> Bei Verschm.grad 1, Übersp.kat. I erhöhte Bemessungsspannung. / <sup>1)</sup> In case of pollution degree 1, overvoltage category I rated voltage is increased.

Flanschdose, löten, von vorn verschraubbar  
Female panel mount connector, solder, front fastened

Flanschdose, löten, von vorn verschraubbar  
Female panel mount connector, solder, front fastened

Abbildung / Figure



Maßzeichnung / Drawing

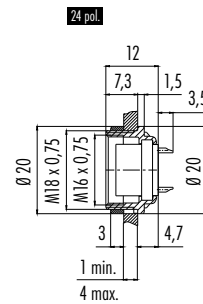
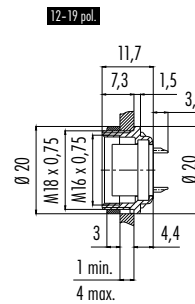
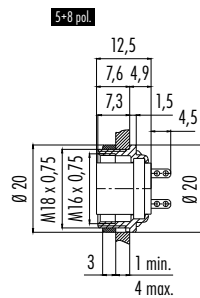
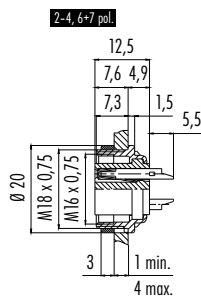

Bestell-Daten / Order Data

Polzahl Contacts	Versilberte Kontakte Silver plated contacts	Vergoldete Kontakte Gold plated contacts
2	09 0304 80 02	09 0304 89 02
3 DIN	09 0308 80 03	09 0308 89 03
4	09 0312 80 04	09 0312 89 04
5	09 0316 80 05	09 0316 89 05
5 (Stereo)	09 0320 80 05	09 0320 89 05
6 DIN	09 0324 80 06	09 0324 89 06
7	09 0328 80 07	09 0328 89 07
7 DIN	–	–
8 DIN	09 0474 80 08	09 0474 89 08

Polzahl Contacts	Versilberte Kontakte Silver plated contacts	Vergoldete Kontakte Gold plated contacts
12	–	09 0332 80 12
14	–	09 0054 80 14
16	–	09 0340 80 16
19	–	09 0336 80 19
24	–	09 0198 80 24

Technische Daten / Specifications

Polzahl	2	3 DIN	4	5	5 (Stereo)	6 DIN	7	7 DIN	8 DIN	12	14	16	19	24	Number of contacts	
Steckverbinder Verriegelung	schrauben/screw														Connector locking system	
Anschlussart	löten/solder														Termination	
Anschlussquerschnitt	max. 0,75 mm <sup>2</sup> (max. AWG 18)									max. 0,25 mm <sup>2</sup> (max. AWG 24)			0,14 mm <sup>2</sup> (26)		Wire gauge	
Kabeldurchlass	—														Cable outlet	
Schutzart	IP40														Degree of protection	
Mechanische Lebensdauer	> 500 Steckzyklen/> 500 mating cycles														Mechanical operation	
Obere Grenztemperatur	+ 85 °C														Upper temperature	
Untere Grenztemperatur	– 40 °C														Lower temperature	
Bemessungsspannung	150 V (250 V)			32 V (60 V)		150 V (250 V)		32 V (125 V)		32 V (60 V)						Rated voltage
Bemessungs-Stoßspannung	1500 V			500 V		1500 V		500 V (800 V)		500 V						Rated impulse voltage
Verschmutzungsgrad	2 (I) <sup>1)</sup>														Pollution degree	
Überspannungskategorie	II (I) <sup>1)</sup>														Overvoltage categorie	
Isolierstoffgruppe	III														Material group	
Bemessungsstrom (40 °C)	7 A			6 A		5 A		5 A			3 A			1 A		Rated current (40 °C)
Durchgangswiderstand	≤ 5 mΩ														≤ 3 mΩ	Contact resistance
Material Kontakt	CuSn (Bronze/bronze)														Material of contact	
Kontaktoberfläche	Ag (Silber/silver)/Au (Gold/gold)									Au (Gold/gold)						Contact plating
Material Kontaktkörper	PBT														Material of contact body	
Material Gehäuse	Zink Druckguss vernickelt/zinc diecasting nickel plated														Material of housing	

Flanschdose, tauchlöten, von vorn verschraubbar  
Female panel mount connector, dip solder, front fastened

Flanschdose, tauchlöten, von vorn verschraubbar  
Female panel mount connector, dip solder, front fastened

Abbildung / Figure



Maßzeichnung / Drawing

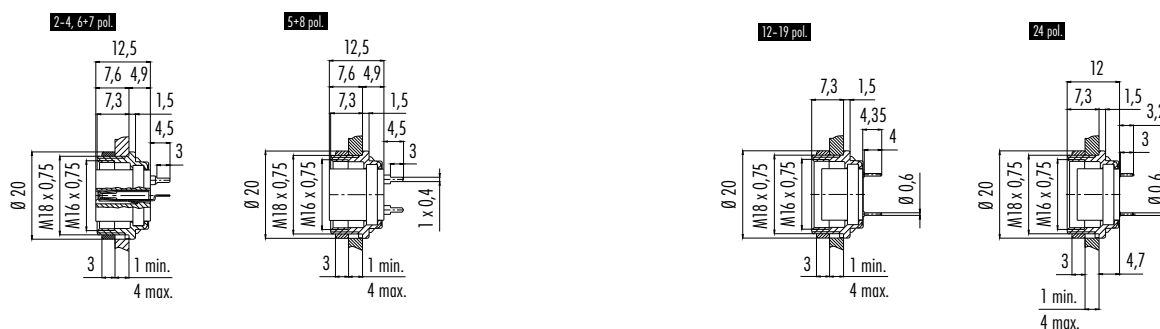

Bestell-Daten / Order Data

Polzahl Contacts	Versilberte Kontakte Silver plated contacts	Vergoldete Kontakte Gold plated contacts
2	09 0304 90 02	09 0304 99 02
3 DIN	09 0308 90 03	09 0308 99 03
4	09 0312 90 04	09 0312 99 04
5	09 0316 90 05	09 0316 99 05
5 (Stereo)	09 0320 90 05	09 0320 99 05
6 DIN	09 0324 90 06	09 0324 99 06
7	09 0328 90 07	09 0328 99 07
7 DIN	—	—
8 DIN	09 0474 90 08	09 0474 99 08

Polzahl Contacts	Versilberte Kontakte Silver plated contacts	Vergoldete Kontakte Gold plated contacts
12	—	09 0332 90 12
14	—	09 0054 90 14
16	—	09 0340 90 16
19	—	09 0336 90 19
24	—	09 0198 90 24

Technische Daten / Specifications

Polzahl	2	3 DIN	4	5	5 (Stereo)	6 DIN	7	7 DIN	8 DIN	12	14	16	19	24	Number of contacts	
Steckverbinder Verriegelung	schrauben/screw														Connector locking system	
Anschlussart	tauchlöten/dip solder														Termination	
Anschlussquerschnitt	—														Wire gauge	
Kabeldurchlass	—														Cable outlet	
Schutzart	IP40														Degree of protection	
Mechanische Lebensdauer	> 500 Steckzyklen/> 500 mating cycles														Mechanical operation	
Obere Grenztemperatur	+ 85 °C														Upper temperature	
Untere Grenztemperatur	- 40 °C														Lower temperature	
Bemessungsspannung	150 V (250 V)			32 V (60 V) 150 V (250 V) 32 V (125 V)			32 V (60 V)								Rated voltage	
Bemessungs-Stoßspannung	1500 V			500 V 1500 V			500 V (800 V)					500 V			Rated impulse voltage	
Verschmutzungsgrad	2 (I) <sup>1)</sup>														Pollution degree	
Überspannungskategorie	II (I) <sup>1)</sup>														Overvoltage categorie	
Isolierstoffgruppe	III														Material group	
Bemessungsstrom (40 °C)	7 A		6 A			5 A			3 A			1 A			Rated current (40 °C)	
Durchgangswiderstand	≤ 5 mΩ														≤ 3 mΩ	Contact resistance
Material Kontakt	CuSn (Bronze/bronze)														Material of contact	
Kontaktoberfläche	Ag (Silber/silver)/Au (Gold/gold)														Au (Gold/gold)	Contact plating
Material Kontaktkörper	PBT														Material of contact body	
Material Gehäuse	Zink Druckguss vernickelt/zinc diecasting nickel plated														Material of housing	

<sup>1)</sup> Bei Verschm.grad 1, Übersp.kat. I erhöhte Bemessungsspannung. / <sup>1)</sup> In case of pollution degree 1, overvoltage category I rated voltage is increased.

**Flanschdose, tauchlöten, von vorn verschraubbar, mit Schirmanbindung**  
 Female panel mount connector, dip solder, front fastened, with shield connection

Abbildung / Figure



Bohrbilder siehe Seite 207  
 Drilling schemes see page 207

Maßzeichnung / Drawing

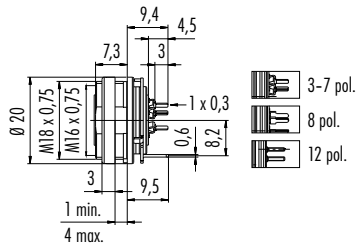

Bestell-Daten / Order Data

Polzahl Contacts	Bestell-Nr. Ordering-No.
3 DIN	09 0308 290 03
4	09 0312 290 04
5	09 0316 290 05
6 DIN	09 0324 290 06
7	09 0328 290 07
8 DIN	09 0474 290 08
12	09 0332 290 12

Technische Daten / Specifications

Polzahl	3 DIN	4	5	6 DIN	7	8 DIN	12	Number of contacts	
Steckverbinder Verriegelung	schrauben/screw							Connector locking system	
Anschlussart	tauchlöten/dip solder							Termination	
Anschlussquerschnitt	—							Wire gauge	
Kabeldurchlass	—							Cable outlet	
Schutzart	IP67							Degree of protection	
Mechanische Lebensdauer	> 500 Steckzyklen/> 500 mating cycles							Mechanical operation	
Obere Grenztemperatur	+ 85 °C							Upper temperature	
Untere Grenztemperatur	- 40 °C							Lower temperature	
Bemessungsspannung	150 V (250 V)			32 V (125 V)		32 V (60 V)		Rated voltage	
Bemessungs-Stoßspannung	1500 V			500 V (800 V)		500 V		Rated impulse voltage	
Verschmutzungsgrad	2 (I) <sup>1)</sup>							Pollution degree	
Überspannungskategorie	II (I) <sup>1)</sup>							Overvoltage categorie	
Isolierstoffgruppe	III							Material group	
Bemessungsstrom (40 °C)	7 A	6 A			5 A		3 A	Rated current (40 °C)	
Durchgangswiderstand	≤ 5 mΩ							≤ 3 mΩ	Contact resistance
Material Kontakt	CuSn (Bronze/bronze)							Material of contact	
Kontaktoberfläche	Ag (Silber/silver)					Au (Gold/gold)		Contact plating	
Material Kontaktkörper	PBT							Material of contact body	
Material Gehäuse	Zink Druckguss vernickelt/zinc diecasting nickel plated							Material of housing	

**Flanschdose, crimpen**  
Female panel mount connector, crimp

Abbildung / Figure



Crimp- und Bandkontakte siehe Seite 208  
Crimp and strip contacts see page 208

**Flanschdose, crimpen, von vorn verschraubbar**  
Female panel mount connector, crimp, front fastened



Crimp- und Bandkontakte siehe Seite 208  
Crimp and strip contacts see page 208

Maßzeichnung / Drawing

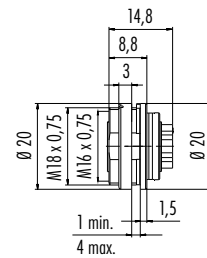
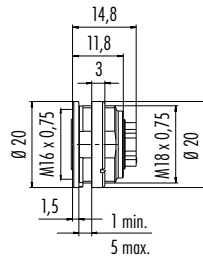

Bestell-Daten / Order Data

Polzahl Contacts	Bestell-Nr. Ordering-No.
4	09 0312 700 04
5	09 0316 700 05
6 DIN	09 0324 700 06
7	09 0328 700 07
8 DIN	09 0474 700 08

Polzahl Contacts	Bestell-Nr. Ordering-No.
4	09 0312 780 04
5	09 0316 780 05
6 DIN	09 0324 780 06
7	09 0328 780 07
8 DIN	09 0474 780 08

Technische Daten / Specifications

Polzahl	4	5	6 DIN	7	8 DIN	Number of contacts
Steckverbinder Verriegelung	schrauben/screw					Connector locking system
Anschlussart	crimpen/crimp					Termination
Anschlussquerschnitt	4–6 pol. 0,14 mm <sup>2</sup> –1,0 mm <sup>2</sup> (AWG 26–AWG 18), 7+8 pol. 0,14 mm <sup>2</sup> –0,75 mm <sup>2</sup> (AWG 26–AWG 20)					Wire gauge
Kabeldurchlass	—					Cable outlet
Schutzart	IP40					Degree of protection
Mechanische Lebensdauer	> 500 Steckzyklen/> 500 mating cycles					Mechanical operation
Obere Grenztemperatur	+ 100 °C					Upper temperature
Untere Grenztemperatur	– 40 °C					Lower temperature
Bemessungsspannung	150 V (250 V)		32 V (125 V)		32 V (60 V)	Rated voltage
Bemessungs-Stoßspannung	1500 V		500 V (800 V)		500 V	Rated impulse voltage
Verschmutzungsgrad	2 (I) <sup>1)</sup>					Pollution degree
Überspannungskategorie	II (I) <sup>1)</sup>					Overvoltage categorie
Isolierstoffgruppe	II					Material group
Bemessungsstrom (40 °C)	6 A		5 A			Rated current (40 °C)
Durchgangswiderstand	≤ 5 mΩ					Contact resistance
Material Kontakt	—					Material of contact
Kontaktoberfläche	Siehe Crimpkontakte Seite 208./See crimp contacts page 208.					Contact plating
Material Kontaktkörper	PBT					Material of contact body
Material Gehäuse	CuZn (Messing, vernickelt/brass, nickel plated)					Material of housing

<sup>1)</sup> Bei Verschm.grad 1, Übersp.kat. I erhöhte Bemessungsspannung. / <sup>1)</sup> In case of pollution degree 1, overvoltage category I rated voltage is increased.

**Flanschdose mit Litzen (200 mm), AWG 22**

Female panel mount connector, with single wires (200 mm), AWG 22

Abbildung / Figure



**Flanschdose, von vorn verschraubbar, mit Litzen (200 mm), AWG 22**

Female panel mount connector, front fastened, with single wires (200 mm), AWG 22



Maßzeichnung / Drawing

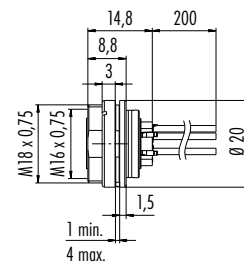
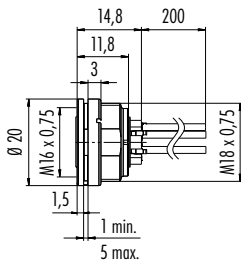

Bestell-Daten / Order Data

Polzahl Contacts	Bestell-Nr. Ordering-No.
4	09 0312 702 04
5	09 0316 702 05
6 DIN	09 0324 702 06
7	09 0328 702 07
8 DIN	09 0474 702 08

Polzahl Contacts	Bestell-Nr. Ordering-No.
4	09 0312 782 04
5	09 0316 782 05
6 DIN	09 0324 782 06
7	09 0328 782 07
8 DIN	09 0474 782 08

Technische Daten / Specifications

Polzahl	4	5	6 DIN	7	8 DIN	Number of contacts
Steckverbinder Verriegelung	schrauben/screw					Connector locking system
Anschlussart	Litzen/single wires					Termination
Anschlussquerschnitt	AWG 22/7 (0,35 mm <sup>2</sup> )					Wire gauge
Kabeldurchlass	—					Cable outlet
Schutzart	IP40					Degree of protection
Mechanische Lebensdauer	> 500 Steckzyklen/> 500 mating cycles					Mechanical operation
Obere Grenztemperatur	+ 100 °C					Upper temperature
Untere Grenztemperatur	- 40 °C					Lower temperature
Bemessungsspannung	150 V (250 V)		32 V (125 V)		32 V (60 V)	Rated voltage
Bemessungs-Stoßspannung	1500 V		500 V (800 V)		500 V	Rated impulse voltage
Verschmutzungsgrad	2 (I) <sup>1)</sup>					Pollution degree
Überspannungskategorie	II (I) <sup>1)</sup>					Overvoltage categorie
Isolierstoffgruppe	III					Material group
Bemessungsstrom (40 °C)	6 A		5 A			Rated current (40 °C)
Durchgangswiderstand	≤ 5 mΩ					Contact resistance
Material Kontakt	CuSn (Bronze/bronze)					Material of contact
Kontaktoberfläche	Ag (Silber/silver)					Contact plating
Material Kontaktkörper	PBT					Material of contact body
Material Gehäuse	CuZn (Messing, vernickelt/brass, nickel plated)					Material of housing



**Flanschdose mit flexibler Leiterplatte, von vorn verschraubbar**  
Female panel mount connector with flexible PCB, front fastened

Abbildung / Figure



**Flanschdose mit flexibler Leiterplatte, von vorn verschraubbar**  
Female panel mount connector with flexible PCB, front fastened



Maßzeichnung / Drawing

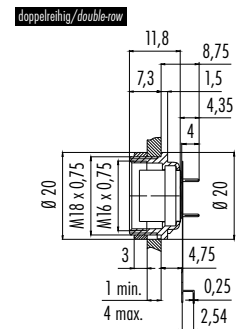
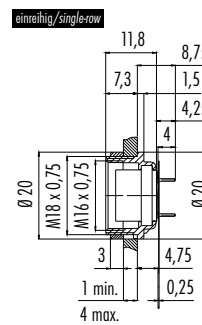
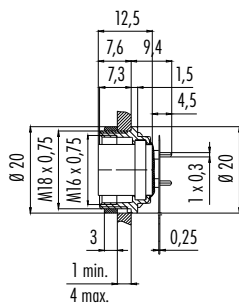

Bestell-Daten / Order Data

Polzahl Contacts	Versilberte Kontakte Silver plated contacts	Vergoldete Kontakte Gold plated contacts	Polzahl Contacts	Einreihig - vergoldete Kontakte Single row - gold plated contacts	Doppelreihig - vergoldete Kontakte Double row - gold plated contacts
7	09 0328 65 07	—	12	09 0332 65 12	09 0332 66 12
8 DIN	09 0474 65 08	—			

Technische Daten / Specifications

Polzahl	7	8 DIN	12	Number of contacts
Steckverbinder Verriegelung	schrauben/screw			Connector locking system
Anschlussart	tauchlöten/dip solder			Termination
Anschlussquerschnitt	—			Wire gauge
Kabeldurchlass	—			Cable outlet
Schutzart	IP40			Degree of protection
Mechanische Lebensdauer	> 500 Steckzyklen/> 500 mating cycles			Mechanical operation
Obere Grenztemperatur	+ 85 °C			Upper temperature
Untere Grenztemperatur	- 40 °C			Lower temperature
Bemessungsspannung	32 V (125 V)	632 V (60 V)		Rated voltage
Bemessungs-Stoßspannung	500 V (800 V)	500 V		Rated impulse voltage
Verschmutzungsgrad	2 (I) <sup>1)</sup>			Pollution degree
Überspannungskategorie	II (I) <sup>1)</sup>			Overvoltage categorie
Isolierstoffgruppe	III			Material group
Bemessungsstrom (40°C)	5 A		3 A	Rated current (40 °C)
Durchgangswiderstand	≤ 5 mΩ		≤ 3 mΩ	Contact resistance
Material Kontakt	CuSn (Bronze/bronze)			Material of contact
Kontaktoberfläche	Ag (Silber/silver)		Au (Gold/gold)	Contact plating
Material Kontaktkörper	PBT			Material of contact body
Material Gehäuse	Zink Druckguss vernickelt/zinc diecasting nickel plated			Material of housing

<sup>1)</sup> Bei Verschm.grad 1, Übersp.kat. I erhöhte Bemessungsspannung. / <sup>1)</sup> In case of pollution degree 1, overvoltage category I rated voltage is increased.

Zeichnungen  
Drawings

09 0327 65 07

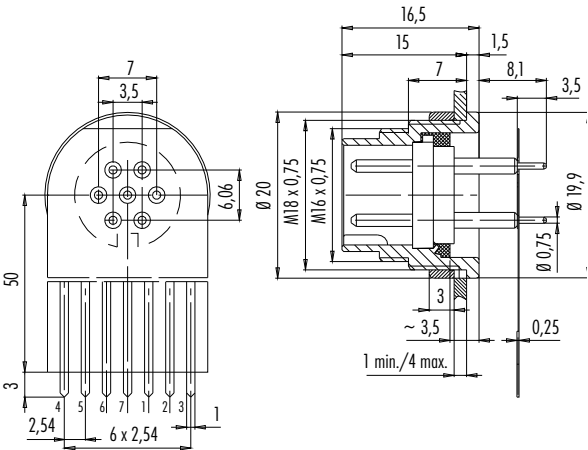

09 0328 65 07

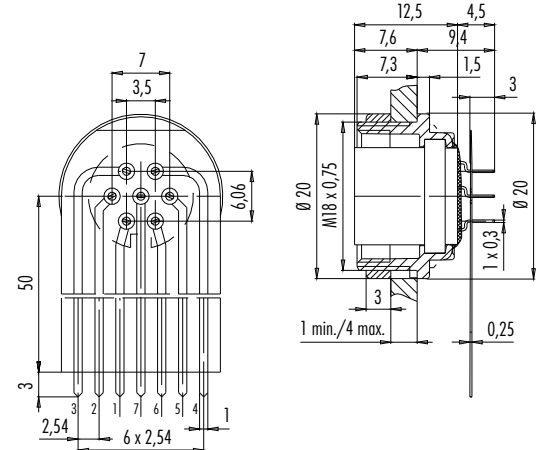

09 0473 65 08

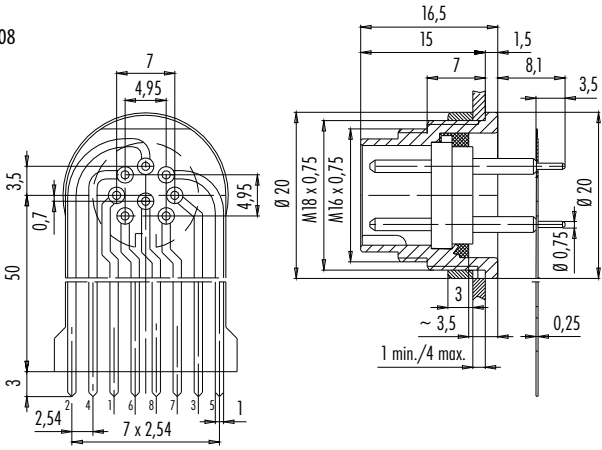

09 0474 65 08

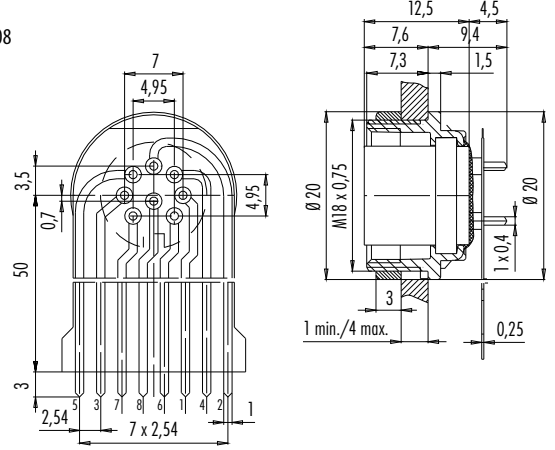

09 0331 65 12

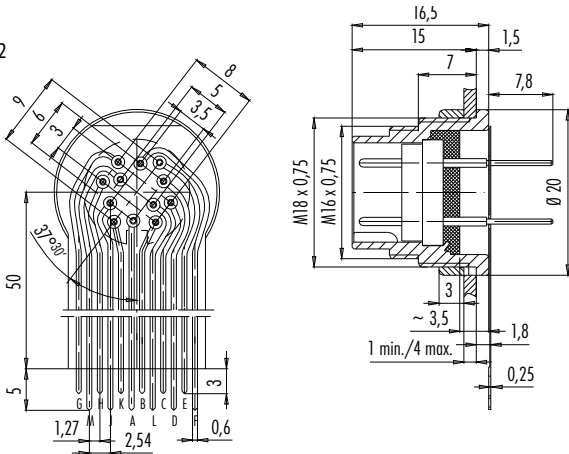

09 0332 65 12

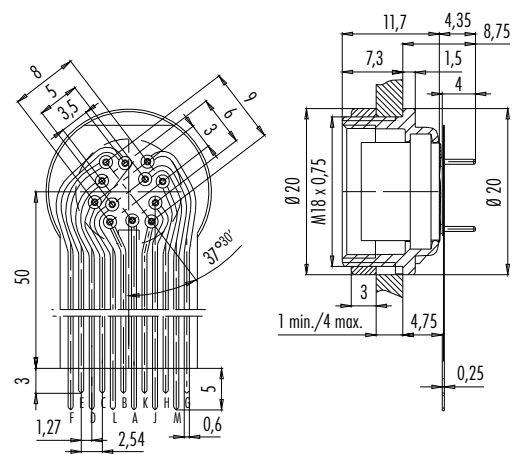

09 0331 66 12

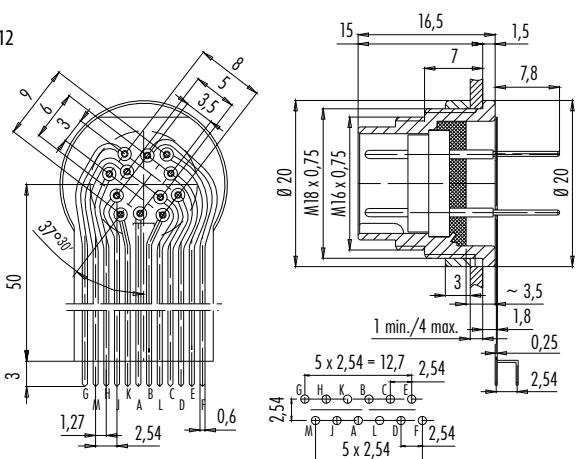

09 0332 66 12

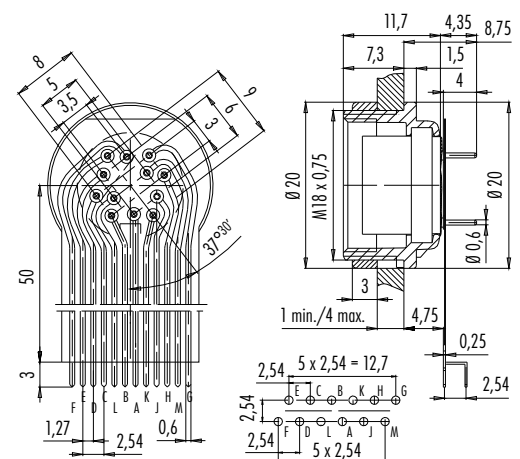

**Polbilder**  
Contact arrangements

**Stifteinsatz (Steckseite)**  
Male insert (mating side)

**Buchseinsatz (Steckseite)**  
Female insert (mating side)

2 pol  
2 contacts

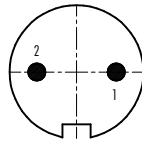

	X	Y
1	3,50	0,00
2	-3,50	0,00

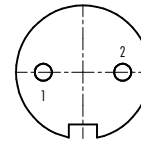

	X	Y
1	-3,50	0,00
2	3,50	0,00

3 pol (DIN 41524)  
3 contacts (DIN 41524)

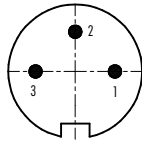

	X	Y
1	3,50	0,00
2	0,00	3,50
3	-3,50	0,00

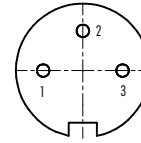

	X	Y
1	-3,50	0,00
2	0,00	3,50
3	3,50	0,00

4 pol  
4 contacts

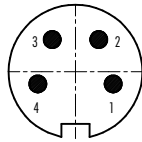

	X	Y
1	3,32	-1,08
2	2,05	2,83
3	-2,05	2,83
4	-3,32	-1,08

Flanschsteckverbinder  
Panel mount connectors

- 1 weiß/white
- 2 braun/brown
- 3 grün/green
- 4 gelb/yellow

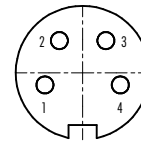

	X	Y
1	-3,32	-1,08
2	-2,05	2,83
3	2,05	2,83
4	3,32	-1,08

Flanschsteckverbinder  
Panel mount connectors

- 1 weiß/white
- 2 braun/brown
- 3 grün/green
- 4 gelb/yellow

5 pol  
5 contacts

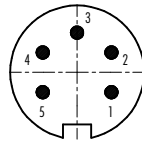

	X	Y
1	3,03	-1,75
2	3,03	1,75
3	0,00	3,50
4	-3,03	1,75
5	-3,03	-1,75

Flanschsteckverbinder  
Panel mount connectors

- 1 weiß/white
- 2 braun/brown
- 3 grün/green
- 4 gelb/yellow
- 5 grau/grey

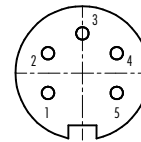

	X	Y
1	-3,03	-1,75
2	-3,03	1,75
3	0,00	3,50
4	3,03	1,75
5	3,03	-1,75

Flanschsteckverbinder  
Panel mount connectors

- 1 weiß/white
- 2 braun/brown
- 3 grün/green
- 4 gelb/yellow
- 5 grau/grey

5 pol Stereo (DIN 41524)  
5 contacts stereo (DIN 41524)

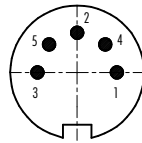

	X	Y
1	3,50	0,00
2	0,00	3,50
3	-3,50	0,00
4	2,47	2,47
5	-2,47	2,47

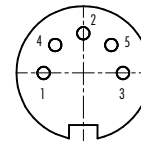

	X	Y
1	-3,50	0,00
2	0,00	3,50
3	3,50	0,00
4	-2,47	2,47
5	2,47	2,47

6 pol (DIN 45322)  
6 contacts (DIN 45322)

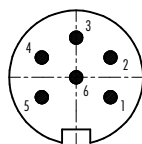

	X	Y
1	3,03	-1,75
2	3,03	1,75
3	0,00	3,50
4	-3,03	1,75
5	-3,03	-1,75
6	0,00	0,00

Flanschsteckverbinder  
Panel mount connectors

- 1 weiß/white
- 2 braun/brown
- 3 grün/green
- 4 gelb/yellow
- 5 grau/grey
- 6 rosa/pink

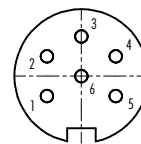

	X	Y
1	-3,03	-1,75
2	-3,03	1,75
3	0,00	3,50
4	3,03	1,75
5	3,03	-1,75
6	0,00	0,00

Flanschsteckverbinder  
Panel mount connectors

- 1 weiß/white
- 2 braun/brown
- 3 grün/green
- 4 gelb/yellow
- 5 grau/grey
- 6 rosa/pink

**Polbilder**  
Contact arrangements

**Stifteinsatz (Steckseite)**  
Male insert (mating side)

**Buchseinsatz (Steckseite)**  
Female insert (mating side)

7 pol  
7 contacts

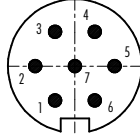

	X	Y
1	-1,75	-3,03
2	-3,50	0,00
3	-1,75	3,03
4	1,75	3,03
5	3,50	0,00
6	1,75	-3,03
7	0,00	0,00

Flanschsteckverbinder  
Panel mount connectors

- 1 weiß/white
- 2 braun/brown
- 3 grün/green
- 4 gelb/yellow
- 5 grau/grey
- 6 rosa/pink
- 7 blau/blue

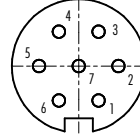

	X	Y
1	1,75	-3,03
2	3,50	0,00
3	1,75	3,03
4	-1,75	3,03
5	-3,50	0,00
6	-1,75	-3,03
7	0,00	0,00

Flanschsteckverbinder  
Panel mount connectors

- 1 weiß/white
- 2 braun/brown
- 3 grün/green
- 4 gelb/yellow
- 5 grau/grey
- 6 rosa/pink
- 7 blau/blue

7 pol (DIN 45329)  
7 contacts (DIN 45329)

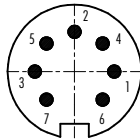

	X	Y
1	3,50	0,00
2	0,00	3,50
3	-3,50	0,00
4	2,47	2,47
5	-2,47	2,47
6	2,47	-2,47
7	-2,47	-2,47

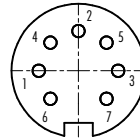

	X	Y
1	-3,50	0,00
2	0,00	3,50
3	3,50	0,00
4	-2,47	2,47
5	2,47	2,47
6	-2,47	-2,47
7	2,47	-2,47

8 pol (DIN 45326)  
8 contacts (DIN 45326)

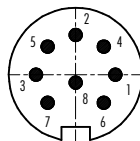

	X	Y
1	3,50	0,00
2	0,00	3,50
3	-3,50	0,00
4	2,47	2,47
5	-2,47	2,47
6	2,47	-2,47
7	-2,47	-2,47
8	0,00	-0,70

Flanschsteckverbinder  
Panel mount connectors

- 1 weiß/white
- 2 braun/brown
- 3 grün/green
- 4 gelb/yellow
- 5 grau/grey
- 6 rosa/pink
- 7 blau/blue
- 8 rot/red

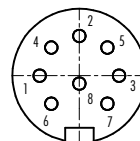

	X	Y
1	-3,50	0,00
2	0,00	3,50
3	3,50	0,00
4	-2,47	2,47
5	2,47	2,47
6	-2,47	-2,47
7	2,47	-2,47
8	0,00	-0,70

Flanschsteckverbinder  
Panel mount connectors

- 1 weiß/white
- 2 braun/brown
- 3 grün/green
- 4 gelb/yellow
- 5 grau/grey
- 6 rosa/pink
- 7 blau/blue
- 8 rot/red

12 pol  
12 contacts

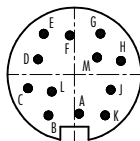

	X	Y
A	0,44	-3,45
B	-2,29	-3,61
C	-4,10	-1,21
D	-3,20	1,34
E	-2,71	3,59
F	-0,41	3,45
G	2,29	3,61
H	4,10	1,21
J	3,20	-1,34
K	2,71	-3,59
L	-2,00	-1,51
M	2,00	1,51

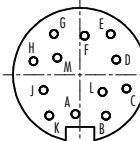

	X	Y
A	-0,44	-3,45
B	2,29	-3,61
C	4,10	-1,21
D	3,20	1,34
E	2,71	3,59
F	0,41	3,45
G	-2,29	3,61
H	-4,10	1,21
J	-3,20	-1,34
K	-2,71	-3,59
L	-2,00	-1,51
M	2,00	1,51

14 pol  
14 contacts

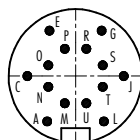

	X	Y
A	-2,50	-4,00
C	-4,25	0,00
E	-2,30	4,00
G	2,30	4,00
J	4,25	0,00
L	2,50	-4,00
M	-0,95	-2,40
N	-2,40	-0,95
O	-2,40	0,95
P	-0,95	2,40
R	0,95	2,40
S	2,40	0,95
T	2,40	-0,95
U	0,95	-2,40

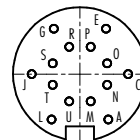

	X	Y
A	2,50	-4,00
C	4,25	0,00
E	2,30	4,00
G	-2,30	4,00
J	-4,25	0,00
L	-2,50	-4,00
M	0,95	-2,40
N	2,40	-0,95
O	2,40	0,95
P	0,95	2,40
R	-0,95	2,40
S	-2,40	0,95
T	-2,40	-0,95
U	-0,95	-2,40

Polbilder  
Contact arrangements

Stifteinsatz (Steckseite)  
Male insert (mating side)

Buchseinsatz (Steckseite)  
Female insert (mating side)

16 pol  
16 contacts

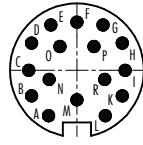

	X	Y
A	-2,50	-4,00
B	-4,00	-2,25
C	-4,25	0,00
D	-4,00	2,40
E	-2,30	4,00
F	0,00	4,25
G	2,30	4,00
H	4,00	2,40
I	4,25	0,00
K	4,00	-2,25
L	2,50	-4,00
M	0,00	-2,60
N	-2,45	-0,80
O	-1,50	2,10
P	1,50	2,10
R	2,40	-0,80

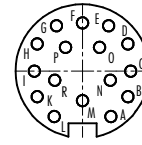

	X	Y
A	2,50	-4,00
B	4,00	-2,25
C	4,25	0,00
D	4,00	2,40
E	2,30	4,00
F	0,00	4,25
G	-2,30	4,00
H	-4,00	2,40
I	-4,25	0,00
K	-4,00	-2,25
L	-2,50	-4,00
M	0,00	-2,60
N	2,45	-0,80
O	1,50	2,10
P	-1,50	2,10
R	-2,40	-0,80

19 pol  
19 contacts

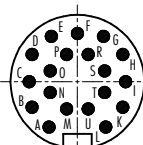

	X	Y
A	-2,50	-4,00
B	-4,00	-2,25
C	-4,25	0,00
D	-4,00	2,40
E	-2,30	4,00
F	0,00	4,25
G	2,30	4,00
H	4,00	2,40
I	4,25	0,00
K	4,00	-2,25
L	2,50	-4,00
M	-0,95	-2,40
N	-2,40	-0,95
O	-2,40	0,95
P	-0,95	2,40
R	0,95	2,40
S	2,40	0,95
T	2,40	-0,95
U	0,95	-2,40

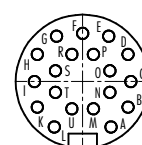

	X	Y
A	2,50	-4,00
B	4,00	-2,25
C	4,25	0,00
D	4,00	2,40
E	2,30	4,00
F	0,00	4,25
G	-2,30	4,00
H	-4,00	2,40
I	-4,25	0,00
K	-4,00	-2,25
L	-2,50	-4,00
M	0,95	-2,40
N	2,40	-0,95
O	2,40	0,95
P	0,95	2,40
R	-0,95	2,40
S	-2,40	0,95
T	-2,40	-0,95
U	-0,95	-2,40

24 pol  
24 contacts

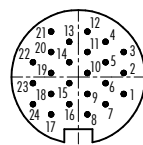

	X	Y
1	4,00	-1,50
2	4,00	0,35
3	4,00	2,20
4	2,40	3,10
5	2,40	1,30
6	2,40	-0,55
7	2,40	-2,40
8	0,80	-3,30
9	0,80	-1,50
10	0,80	0,35
11	0,80	2,20
12	0,80	4,00
13	-0,80	3,10
14	-0,80	1,30
15	-0,80	-0,55
16	-0,80	-2,40
17	-2,40	-3,30
18	-2,40	-1,50
19	-2,40	0,35
20	-2,40	2,20
21	-2,40	4,00
22	-4,00	1,30
23	-4,00	-0,55
24	-4,00	-2,40

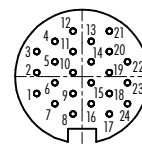

	X	Y
1	-4,00	-1,50
2	-4,00	0,35
3	-4,00	2,20
4	-2,40	3,10
5	-2,40	1,30
6	-2,40	-0,55
7	-2,40	-2,40
8	-0,80	-3,30
9	-0,80	-1,50
10	-0,80	0,35
11	-0,80	2,20
12	-0,80	4,00
13	0,80	3,10
14	0,80	1,30
15	0,80	-0,55
16	0,80	-2,40
17	2,40	-3,30
18	2,40	-1,50
19	2,40	0,35
20	2,40	2,20
21	2,40	4,00
22	4,00	1,30
23	4,00	-0,55
24	4,00	-2,40

Montageausschnitt  
Panel cut out

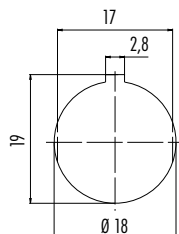

Empfohlene Bohrdurchmesser für Leiterplatten  
Recommended drill holes for PCB

- 2 – 8 pol 1,1 mm
- 12 – 24 pol 0,8 mm

**Bohrbilder Stifteinsatz (Leiterplatte), Schirmpinvariante**  
 Drilling schemes male insert (PCB), shield pin version

**Bohrbilder Buchseneinsatz (Leiterplatte), Schirmpinvariante**  
 Drilling schemes female insert (PCB), shield pin version

3 pol  
3 contacts

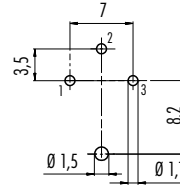

4 pol  
4 contacts

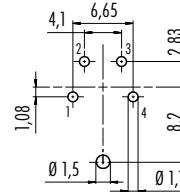

5 pol  
5 contacts

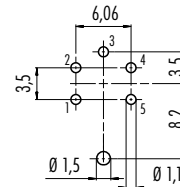
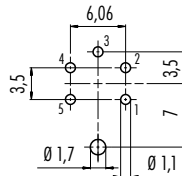

6 pol (DIN 45322)  
6 contacts (DIN 45322)

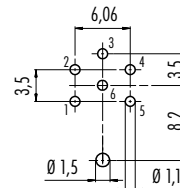
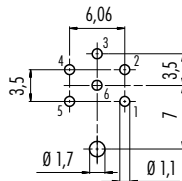

7 pol  
7 contacts

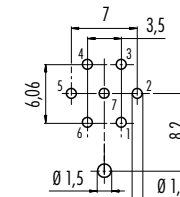

8 pol (DIN 45326)  
8 contacts (DIN 45326)

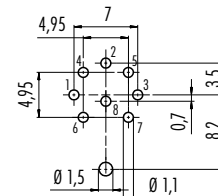
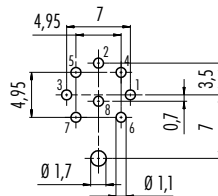

12 pol  
12 contacts

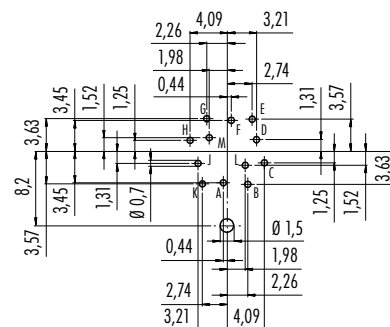
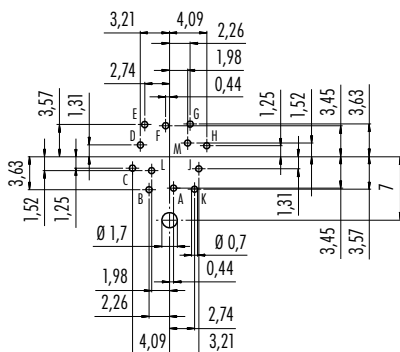

**Einzelkontakt (Stift), VPE 50 Stück**  
Single contact (Male), PU 50 pieces

Abbildung / Figure



Maßzeichnung / Drawing



**Einzelkontakt (Buchse), VPE 50 Stück**  
Single contact (Female), PU 50 pieces

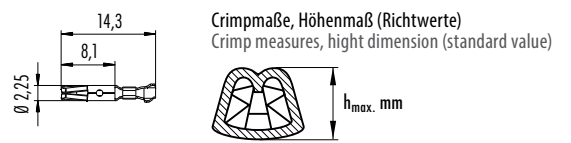

**Technische Daten**  
Specifications

Anschlussquerschnitt mm <sup>2</sup>	0,14 mm <sup>2</sup> – 0,25 mm <sup>2</sup>		0,35 mm <sup>2</sup> – 0,5 mm <sup>2</sup>		0,75 mm <sup>2</sup> – 1,0 mm <sup>2</sup>		Wire gauge mm <sup>2</sup>
Leiterquerschnitt mm <sup>2</sup>	0,14 mm <sup>2</sup> (AWG 26)	0,25 mm <sup>2</sup> (AWG 24)	0,35 mm <sup>2</sup> (AWG 22)	0,5 mm <sup>2</sup> (AWG 20)	0,75 mm <sup>2</sup> (AWG 20-18)	1,0 mm <sup>2</sup> (AWG 18-16)	Conductor cross section mm <sup>2</sup>
Isolierung Ø	Ø 1,0 – 2,0 mm				Ø 1,6 – 2,1 mm		Insulation Ø
Crimpmaße (Richtwert)	0,9 – 1,0 mm	0,92 – 1,09 mm	0,93 – 1,1 mm	0,95 – 1,12 mm	1,2 – 1,33 mm	1,3 – 1,45 mm	Crimp measures (standard value)
Crimppauszugskraft nach DIN EN 60352-2	24 N	42 N	53 N	73 N	90 N	110 N	Crimp extraction force acc. to DIN EN 60352-2

**Bandkontakt (Stift)**  
Strip contact (Male)

Abbildung / Figure

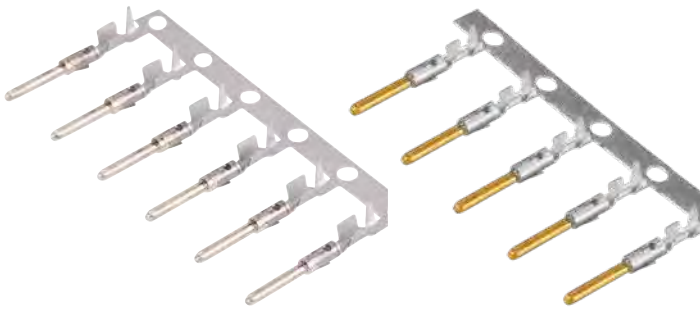

**Bandkontakt (Buchse)**  
Strip contact (Female)

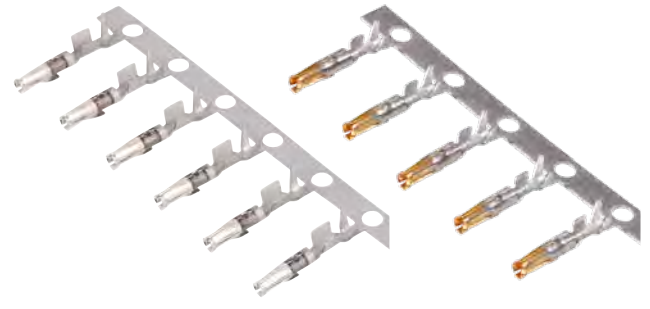

Bestell-Daten / Order Data

Kontakt-Ø Pin-Ø	Isolierung-Ø Insulating-Ø	AQ mm <sup>2</sup> WG mm <sup>2</sup>	Aufmachung Pieces	Stück Pieces	Silber (Ag) Silver (Ag)	Gold (Au) Gold (Au)
1,5 mm	1,0 – 2,0 mm	0,14 – 0,25	Einzel/single	50	61 0799 085 00	61 0799 098 00
			Band/strip	200	65 0799 085 01	65 0799 098 01
			Band/strip	2000	65 0799 085 02	65 0799 098 02
			Band/strip	4000	65 0799 085 04	65 0799 098 04
			Band/strip	10.000	65 0799 085 10	65 0799 098 10
			Band/strip	10.000	65 0799 085 10	65 0799 098 10
	1,0 – 2,0 mm	0,35 – 0,5	Einzel/single	50	61 0795 085 00	61 0795 098 00
			Band/strip	200	65 0795 085 01	65 0795 098 01
			Band/strip	2000	65 0795 085 02	65 0795 098 02
			Band/strip	4000	65 0795 085 04	65 0795 098 04
			Band/strip	10.000	65 0795 085 10	65 0795 098 10
			Band/strip	10.000	65 0795 085 10	65 0795 098 10
1,6 – 2,1 mm	1,0 – 2,0 mm	0,75 – 1,0	Einzel/single	50	61 0796 085 00	61 0796 098 00
			Band/strip	200	65 0796 085 01	65 0796 098 01
			Band/strip	2000	65 0796 085 02	65 0796 098 02
			Band/strip	4000	65 0796 085 04	65 0796 098 04
			Band/strip	10.000	65 0796 085 10	65 0796 098 10
	1,6 – 2,1 mm	0,75 – 1,0	Einzel/single	50	61 0798 085 00	61 0798 098 00
			Band/strip	200	65 0798 085 01	65 0798 098 01
			Band/strip	2000	65 0798 085 02	65 0798 098 02
			Band/strip	4000	65 0798 085 04	65 0798 098 04
			Band/strip	10.000	65 0798 085 10	65 0798 098 10

Kontakt-Ø Pin-Ø	Isolierung-Ø Insulating-Ø	AQ mm <sup>2</sup> WG mm <sup>2</sup>	Aufmachung Pieces	Stück Pieces	Silber (Ag) Silver (Ag)	Gold (Au) Gold (Au)
1,5 mm	1,0 – 2,0 mm	0,14 – 0,25	Einzel/single	50	61 0800 085 00	61 0800 098 00
			Band/strip	200	65 0800 085 01	65 0800 098 01
			Band/strip	2000	65 0800 085 02	65 0800 098 02
			Band/strip	4000	65 0800 085 04	65 0800 098 04
			Band/strip	10.000	65 0800 085 10	65 0800 098 10
			Band/strip	10.000	65 0800 085 10	65 0800 098 10
	1,0 – 2,0 mm	0,35 – 0,5	Einzel/single	50	61 0797 085 00	61 0797 098 00
			Band/strip	200	65 0797 085 01	65 0797 098 01
			Band/strip	2000	65 0797 085 02	65 0797 098 02
			Band/strip	4000	65 0797 085 04	65 0797 098 04
			Band/strip	10.000	65 0797 085 10	65 0797 098 10
			Band/strip	10.000	65 0797 085 10	65 0797 098 10
1,6 – 2,1 mm	1,0 – 2,0 mm	0,75 – 1,0	Einzel/single	50	61 0798 085 00	61 0798 098 00
			Band/strip	200	65 0798 085 01	65 0798 098 01
			Band/strip	2000	65 0798 085 02	65 0798 098 02
			Band/strip	4000	65 0798 085 04	65 0798 098 04
			Band/strip	10.000	65 0798 085 10	65 0798 098 10
	1,6 – 2,1 mm	0,75 – 1,0	Einzel/single	50	61 0798 085 00	61 0798 098 00
			Band/strip	200	65 0798 085 01	65 0798 098 01
			Band/strip	2000	65 0798 085 02	65 0798 098 02
			Band/strip	4000	65 0798 085 04	65 0798 098 04
			Band/strip	10.000	65 0798 085 10	65 0798 098 10

**Crimpzange für Einzelkontakte**  
Crimping tool for single contacts

Abbildung / Figure



Maßzeichnung / Drawing

Bestell-Daten / Order Data

Bestell-Nr.  
Ordering-No.

66 0001 014 100

**Montageschlüssel für Flanschsteckverbinder**  
Mounting spanner for panel mount connectors

Abbildung / Figure



Maßzeichnung / Drawing

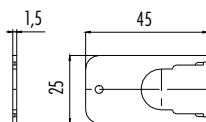

Bestell-Daten / Order Data

Bestell-Nr.  
Ordering-No.

07 0010 001

**Crimpzange für Bandkontakte**  
Crimping tool for strip contacts



Bestell-Daten / Order Data

Bestell-Nr.  
Ordering-No.

67 0001 014 100

**Viereckflansch für Flanschsteckverbinder, IP40**  
Rectangular flange for panel mount connectors, IP40

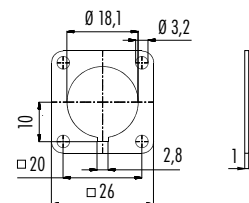

Bestell-Daten / Order Data

Bestell-Nr.  
Ordering-No.

04 0106 001



**Sechskantmutter**  
Hexagonal nut

Abbildung / Figure



Maßzeichnung / Drawing

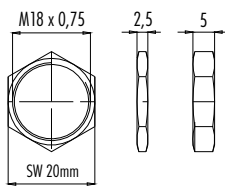

Bestell-Daten / Order Data

Stärke Thickness	Bestell-Nr. Ordering-No.
2,5 mm	01 0146 001
5 mm	01 5006 001

**Lötösenring, IP40**  
Solder eye ring, IP40

Abbildung / Figure



Maßzeichnung / Drawing

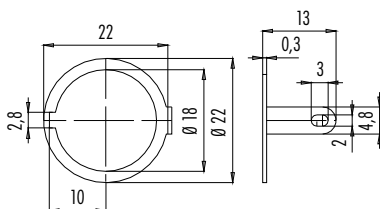

Bestell-Daten / Order Data

Bestell-Nr. Ordering-No.
04 0183 009

**Ringmutter für Befestigungsgewinde**  
Ring nut for fixing thread

Abbildung / Figure



Maßzeichnung / Drawing

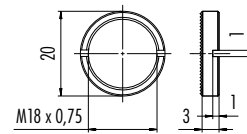

Bestell-Daten / Order Data

Bestell-Nr. Ordering-No.
01 0010 001 Mit Rändel/with knurled screw

**Blindstopfen, IP67**  
Blind plug, IP67

Abbildung / Figure



Maßzeichnung / Drawing

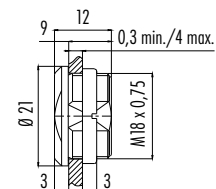

Bestell-Daten / Order Data

Höhe Height	Bestell-Nr. Ordering-No.
12 mm	08 2668 000 001

**Schutzkappe für Flanschstecker, IP40**

Protection cap for male panel mount connector, IP40

Abbildung / Figure



Maßzeichnung / Drawing

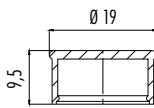

Bestell-Daten / Order Data

Höhe Height	Bestell-Nr. Ordering-No.
9,5 mm	02 0054 000

**Schutzkappe für Flanschdose, IP40**

Protection cap for female panel mount connector, IP40



Maßzeichnung / Drawing

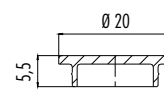

Bestell-Daten / Order Data

Höhe Height	Bestell-Nr. Ordering-No.
5,5 mm	02 0055 001
	02 0055 000 schwarz/black

**Distanzhülse für Flanschsteckverbinder, Tauchlöt Ausführung, 2–19 pol**

Distance shell for panel mount connectors, dip solder version, 2–19 contacts

Abbildung / Figure



Maßzeichnung / Drawing

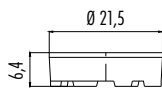

Leiterplattendicke: max. 1,5 mm  
Thickness of PCB: max. 1,5 mm

Bestell-Daten / Order Data

Bestell-Nr. Ordering-No.
02 0007 000

**Montageschlüssel für Kabelsteckverbinder**

Mounting spanner for cable connectors



Maßzeichnung / Drawing

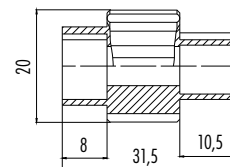

Bestell-Daten / Order Data

Bestell-Nr. Ordering-No.
02 1785 000

**Löswerkzeug für Kontakte**  
Extraction tool for contacts

Abbildung / Figure



Maßzeichnung / Drawing

**Bestell-Daten / Order Data**

Bestell-Nr.  
Ordering-No.

07 0090 000