

**Kabelstecker mit X-Kodierung, Schneidklemmanschluss, schirmbar**  
Male cable connector with X-coding, IDT connection, shieldable

**Kabeldose mit X-Kodierung, Schneidklemmanschluss, schirmbar**  
Female cable connector with X-coding, IDT connection, shieldable

Abbildung / Figure



Maßzeichnung / Drawing

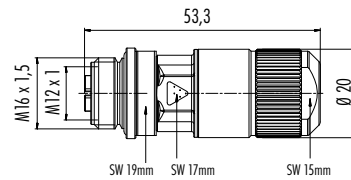
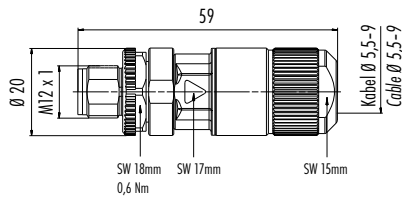

Bestell-Daten / Order Data

Polzahl Contacts	Kabeldurchlass Cable outlet	Bestell-Nr. Ordering-No.
8	5,5–9 mm	99 3787 810 08

Polzahl Contacts	Kabeldurchlass Cable outlet	Bestell-Nr. Ordering-No.
8	5,5–9 mm	99 3788 810 08

Technische Daten / Specifications

Polzahl	8	Number of contacts
Steckverbinder Verriegelung	Schrauben/screw	Connector locking system
Anschlussart	Schneidklemm/IDT connection	Termination
Anschlussquerschnitt	AWG 27–AWG 22	Wire gauge
Kabeldurchlass	5,5–9 mm	Cable outlet
Schutzart	IP67	Degree of protection
Mechanische Lebensdauer	> 100 Steckzyklen/> 100 mating cycles	Mechanical operation
Obere Grenztemperatur	+ 85 °C	Upper temperature
Untere Grenztemperatur	– 40 °C	Lower temperature
Bemessungsspannung	50 V AC, 60 V DC	Rated voltage
Übertragungseigenschaft	CAT 6 <sub>A</sub>	Transmission characteristic
Verschmutzungsgrad	3	Pollution degree
Überspannungskategorie	II	Overvoltage categorie
Isolierstoffgruppe	II	Material group
Bemessungsstrom (40 °C)	0,5 A	Rated current (40 °C)
Durchgangswiderstand	≤ 10 mΩ	Contact resistance
Material Kontakt	CuZn (Messing/brass)	Material of contact
Kontaktoberfläche	Au (Gold/gold)	Contact plating
Material Kontaktkörper	PA	Material of contact body
Material Gehäuse	CuZn (Messing vernickelt/brass nickel plated), Zink Druckguss vernickelt/zinc diecasting nickel plated	Material of housing

**RJ45-Stecker, schirmbar**  
RJ45 connector, shieldable

Abbildung / Figure

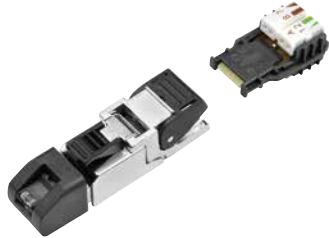

Maßzeichnung / Drawing

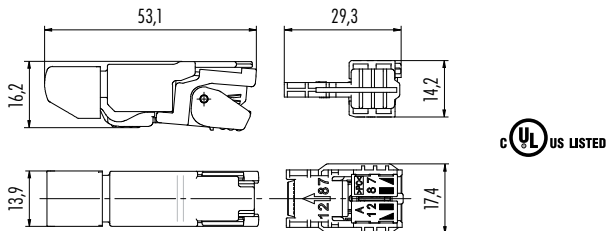

Bestell-Daten / Order Data

Polzahl Contacts	Kabeldurchlass Cable outlet	Anschlussquerschnitt Wire gauge	Anschluss-Standard Connection standard	Bestell-Nr. Ordering-No.
4	5–9 mm	AWG 24–22/1 AWG 27–22/7	TIA 568 Profinet	99 9647 810 04
8	5–9 mm	AWG 26–24/1 AWG 27–24/7	TIA 568 A	99 9687 805 08
		AWG 24–22/1 AWG 27–22/7	TIA 568 A	99 9687 810 08
		AWG 26–24/1 AWG 27–24/7	TIA 568 B	99 9687 809 08
		AWG 24–22/1 AWG 27–22/7	TIA 568 B	99 9687 814 08

Technische Daten / Specifications

Polzahl	4	8	Number of contacts
Steckverbinder Verriegelung	Rastverriegelung/snap locking		Connector locking system
Anschlussart	Durchdringtechnik/piercing technology		Termination
Anschlussquerschnitt	AWG 27–AWG 22		Wire gauge
Kabeldurchlass	5–9 mm		Cable outlet
Schutzart	IP20		Degree of protection
Mechanische Lebensdauer	> 750 Steckzyklen/> 750 mating cycles		Mechanical operation
Obere Grenztemperatur	+ 85 °C		Upper temperature
Untere Grenztemperatur	– 40 °C		Lower temperature
Bemessungsspannung	50 V DC		Rated voltage
Übertragungseigenschaft	CAT 6 <sub>n</sub>		Transmission characteristic
Verschmutzungsgrad	2		Pollution degree
Überspannungskategorie	III		Overvoltage categorie
Isolierstoffgruppe	III a		Material group
Bemessungsstrom (40°C)	1,3 A		Rated current (40 °C)
Durchgangswiderstand	≤ 20 mΩ		Contact resistance
Material Kontakt	Federstahl/spring steel		Material of contact
Kontaktoberfläche	Au (Gold/gold)		Contact plating
Material Kontaktkörper	PC		Material of contact body
Material Gehäuse	Zink Druckguss vernickelt/zinc diecasting nickel plated		Material of housing

Montageanleitung  
Assembly instruction

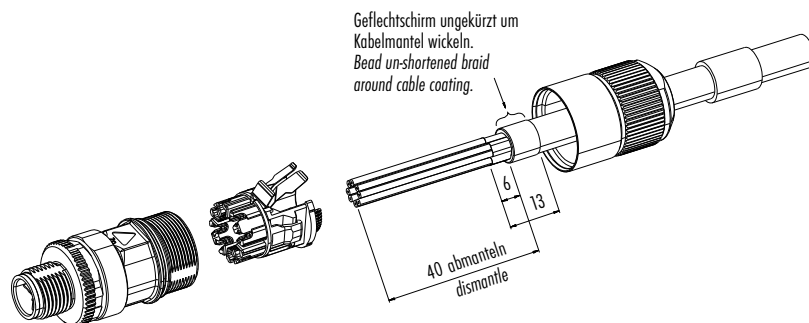

Einzelteildarstellung  
Component part drawing

Kabelsteckverbinder  
Cable connectors

1. Vormontierte Druckschraube.
2. Zusatzdichtung für Kabel-Ø 5,5-7,5 mm.
3. Adervorsortierung.
4. Steckereinsatz.

1. Premounted pressing screw.
2. Additional sealing for cable-Ø 5.5-7.5 mm.
3. Wire manager.
4. Male insert.

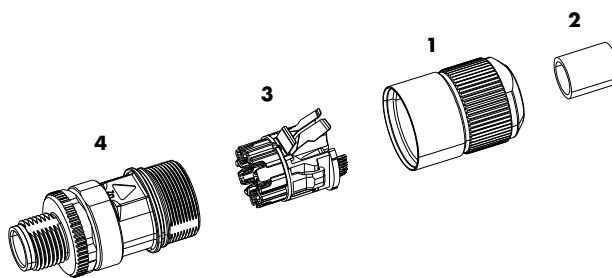

**Verbindungsleitung, 2 Kabelstecker M12 x 1, geschirmt**  
 Connecting cable, 2 male cable connectors M12 x 1, shielded

Abbildung / Figure



**Verbindungsleitung, Kabelstecker M12 x 1 – Kabeldose M12 x 1, geschirmt**  
 Connecting cable, male cable connector M12 x 1 – female cable connector M12 x 1, shielded



Maßzeichnung / Drawing

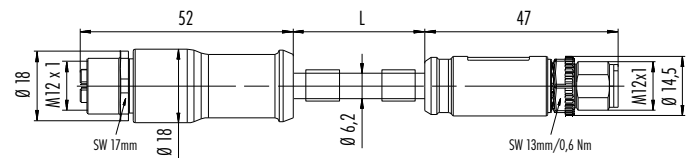
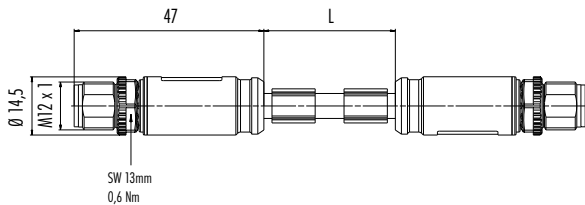

Bestell-Daten / Order Data

Polzahl Contacts	Kabelmantel Cable jacket	Kabellänge Cable length	Bestell-Nr. Ordering-No.
8	PUR	2 m	79 9722 020 08
		5 m	79 9722 050 08
		10 m	79 9722 100 08

Polzahl Contacts	Kabelmantel Cable jacket	Kabellänge Cable length	Bestell-Nr. Ordering-No.
8	PUR	2 m	79 9724 020 08
		5 m	79 9724 050 08
		10 m	79 9724 100 08

Technische Daten / Specifications

Polzahl	8	Number of contacts
Steckverbinder Verriegelung	schrauben/screw	Connector locking system
Anschlussart	crimpen, am Kabel angespritzt/crimp, moulded	Termination
Anschlussquerschnitt	AWG 26/7	Wire gauge
Kabeldurchlass	—	Cable outlet
Schutzart	IP67	Degree of protection
Mechanische Lebensdauer	> 100 Steckzyklen/> 100 mating cycles	Mechanical operation
Obere Grenztemperatur	+ 85 °C	Upper temperature
Untere Grenztemperatur	- 40 °C	Lower temperature
Bemessungsspannung	50 V AC, 60 V DC	Rated voltage
Übertragungseigenschaft	CAT 6 <sub>n</sub>	Rated impulse voltage
Verschmutzungsgrad	3	Pollution degree
Überspannungskategorie	II	Overvoltage categorie
Isolierstoffgruppe	II	Material group
Bemessungsstrom (40°C)	0,5 A	Rated current (40 °C)
Durchgangswiderstand	≤ 10 mΩ	Contact resistance
Material Kontakt	Stift/pin CuZn (Messing/brass), Buchse/socket CuSn (Bronze/bronze)	Material of contact
Kontaktoberfläche	Au (Gold/gold)	Contact plating
Material Kontaktkörper	PA/PUR	Material of contact body
Material Gehäuse	PUR	Material of housing

Verbindungsleitung, Kabelstecker M12 x 1 – RJ45-Stecker, geschirmt  
 Connecting cable, male cable connector M12 x 1 – RJ45 connector, shielded

Abbildung / Figure



Maßzeichnung / Drawing

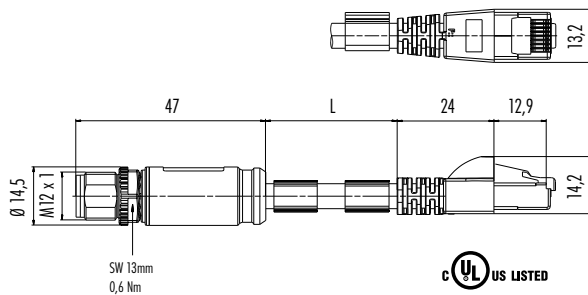

Bestell-Daten / Order Data

Polzahl Contacts	Kabelmantel Cable jacket	Kabellänge Cable length	Bestell-Nr. Ordering-No.
8	PUR	2 m	79 9723 020 08
		5 m	79 9723 050 08
		10 m	79 9723 100 08

Technische Daten / Specifications

Polzahl	8	Number of contacts
Steckverbinder Verriegelung	Schrauben/Rastverriegelung/screw/snap locking	Connector locking system
Anschlussart	crimpen, am Kabel angespritzt/crimp, moulded	Termination
Anschlussquerschnitt	AWG 26/7	Wire gauge
Kabeldurchlass	—	Cable outlet
Schutzart	IP67/RJ45 IP20	Degree of protection
Mechanische Lebensdauer	> 100 Steckzyklen/> 100 mating cycles/> 750 Steckzyklen/> 750 mating cycles	Mechanical operation
Obere Grenztemperatur	+ 85 °C	Upper temperature
Untere Grenztemperatur	- 40 °C	Lower temperature
Bemessungsspannung	50 V AC, 60 V DC	Rated voltage
Übertragungseigenschaft	CAT 6 <sub>A</sub>	Rated impulse voltage
Verschmutzungsgrad	2	Pollution degree
Überspannungskategorie	II	Overvoltage categorie
Isolierstoffgruppe	II	Material group
Bemessungsstrom (40°C)	0,5 A	Rated current (40 °C)
Durchgangswiderstand	≤ 10 mΩ/≤ 20 mΩ	Contact resistance
Material Kontakt	CuZn (Messing/brass), Federstahl/spring steel	Material of contact
Kontaktoberfläche	Au (Gold/gold)	Contact plating
Material Kontaktkörper	PA/PUR	Material of contact body
Material Gehäuse	PUR	Material of housing

**Technische Daten**  
Specifications

**Geschirmtes Kabel S/FTP CAT 7**  
Shielded cable S/FTP CAT 7

Polzahl	8	Number of contacts
Querschnitt mm <sup>2</sup> <sup>1)</sup>	4 x 2 x AWG 26/7	Wire gauge mm <sup>2</sup> <sup>1)</sup>
Material Mantel	PUR grün/green	Material jacket
Isolation Litze	PE	Insulation wire
Litzenaufbau (mm)	7 x 0,16 (AWG 26)	Design of wire (mm)
Kabelmantel Ø (mm)	6,2	Cable jacket Ø (mm)
Leiterwiderstand	14,5 Ω/Km (20 °C)/100 m	Resistance of wire
Temperaturbereich (Kabel bewegt)	- 10 °C /+ 60 °C	Temperature range (cable in move)
Temperaturbereich (Kabel fest)	- 40 °C /+ 85 °C	Temperature range (cable not in move)
Biegeradius (Kabel bewegt)	≥ 50 mm	Bending radius (cable in move)
Biegeradius (Kabel fest)	≥ 25 mm	Bending radius (cable not in move)
Zulassung	E 344985	Approval
Bedeckung Schirmgeflecht	60 %	Cover screen grid

<sup>1)</sup> Vergleichbare AWG Leiter siehe technische Informationen./ <sup>1)</sup> Comparable AWG conductors see technical information.

**Flanschdose mit X-Kodierung, tauchlöten**  
 Female panel mount connector with X-coding, dip solder

Abbildung / Figure



**Flanschdose mit X-Kodierung, von vorn verschraubbar, tauchlöten**  
 Female panel mount connector with X-coding, front fastened, dip solder



Maßzeichnung / Drawing

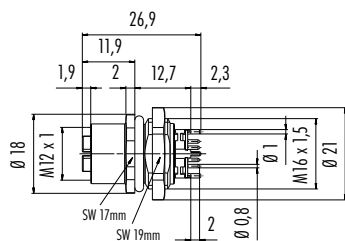

Sechskantmutter lose beigelegt  
 Hexagon nut enclosed loose

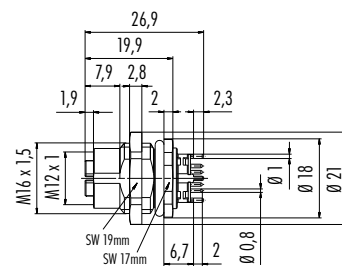

Sechskantmutter lose beigelegt  
 Hexagon nut enclosed loose

Bestell-Daten / Order Data

Polzahl Contacts	Befestigungsgewinde Fixing thread	Bestell-Nr. Ordering-No.
8	M16 x 1,5	09 3782 95 08

Polzahl Contacts	Befestigungsgewinde Fixing thread	Bestell-Nr. Ordering-No.
8	M16 x 1,5	09 3782 91 08

Technische Daten / Specifications

Polzahl	8	Number of contacts
Steckverbinder Verriegelung	schrauben/screw	Connector locking system
Anschlussart	tauchlöten/dip solder	Termination
Anschlussquerschnitt	—	Wire gauge
Kabeldurchlass	—	Cable outlet
Schutzart	IP67	Degree of protection
Mechanische Lebensdauer	> 100 Steckzyklen/> 100 mating cycles	Mechanical operation
Obere Grenztemperatur	+ 85 °C	Upper temperature
Untere Grenztemperatur	- 40 °C	Lower temperature
Bemessungsspannung	50 V AC, 60 V DC	Rated voltage
Übertragungseigenschaft	CAT 6 <sub>A</sub>	Rated impulse voltage
Verschmutzungsgrad	3	Pollution degree
Überspannungskategorie	II	Overvoltage categorie
Isolierstoffgruppe	III	Material group
Bemessungsstrom (40°C)	0,5 A	Rated current (40 °C)
Durchgangswiderstand	≤ 10 mΩ	Contact resistance
Material Kontakt	CuSn (Bronze/bronze)	Material of contact
Kontaktoberfläche	Au (Gold/gold)	Contact plating
Material Kontaktkörper	PA	Material of contact body
Material Gehäuse	Zink Druckguss vernickelt/zinc diecasting nickel plated	Material of housing

**Flanschdose mit X-Kodierung, tauchlöten, Gehäusekontaktierung fest/über Feder**  
 Female panel mount connector with X-coding, dip solder, contact carrier fix/via undular washer

Abbildung / Figure



**Flanschdose mit X-Kodierung, tauchlöten, gewinkelt, Gehäusekontaktierung fest/über Feder**  
 Female angled panel mount connector with X-coding, dip solder, contact carrier fix/via undular washer



Maßzeichnung / Drawing

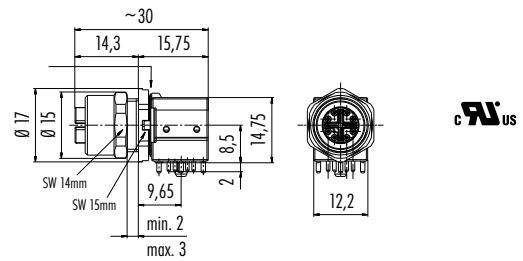
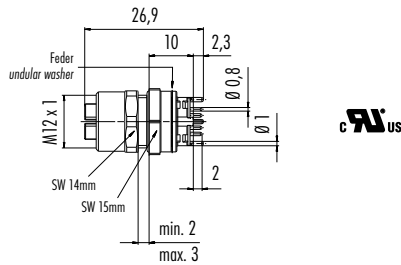

Bestell-Daten / Order Data

Polzahl Contacts	Befestigungsgewinde Fixing thread	Kontaktierung Contact carrier	Bestell-Nr. Ordering-No.	Polzahl Contacts	Befestigungsgewinde Fixing thread	Kontaktierung Contact carrier	Bestell-Nr. Ordering-No.
8	M16 x 1,5	fest/fix	99 3782 210 08	8	M16 x 1,5	fest/fix	99 3782 213 08
		über Feder/ via undular washer	99 3782 200 08			über Feder/ via undular washer	99 3782 202 08

Technische Daten / Specifications

Polzahl	8	Number of contacts
Steckverbinder Verriegelung	schrauben/screw	Connector locking system
Anschlussart	tauchlöten/dip solder	Termination
Anschlussquerschnitt	—	Wire gauge
Kabeldurchlass	—	Cable outlet
Schutzart	IP67	Degree of protection
Mechanische Lebensdauer	> 100 Steckzyklen/> 100 mating cycles	Mechanical operation
Obere Grenztemperatur	+ 85 °C	Upper temperature
Untere Grenztemperatur	- 40 °C	Lower temperature
Bemessungsspannung	50 V AC, 60 V DC	Rated voltage
Übertragungseigenschaft	CAT 6 <sub>A</sub>	Rated impulse voltage
Verschmutzungsgrad	3	Pollution degree
Überspannungskategorie	II	Overvoltage categorie
Isolierstoffgruppe	III	Material group
Bemessungsstrom (40°C)	0,5 A	Rated current (40 °C)
Durchgangswiderstand	≤ 10 mΩ	Contact resistance
Material Kontakt	CuSn (Bronze/bronze)	Material of contact
Kontaktoberfläche	Au (Gold/gold)	Contact plating
Material Kontaktkörper	PA	Material of contact body
Material Gehäuse	CuZn (Messing vernickelt/brass nickel plated), Zink Druckguss vernickelt/zinc diecasting nickel plated	Material of housing



**Flanschdose mit X-Kodierung, von vorn verschraubbar, mit Ethernetkabel**  
 Female panel mount connector with X-coding, front fastened, with Ethernet cable

Abbildung / Figure



**Einbaudose, SMT, mit Gehäuse, schirmbar**  
 Female receptacle, SMT, with housing, shieldable



Bohrbilder siehe Seite 782  
 Drilling schemes see page 782

Maßzeichnung / Drawing

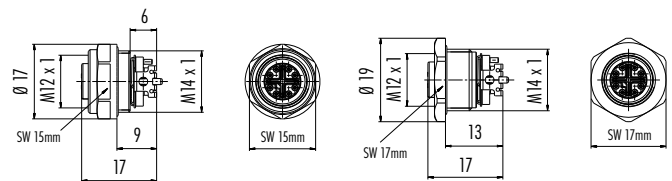
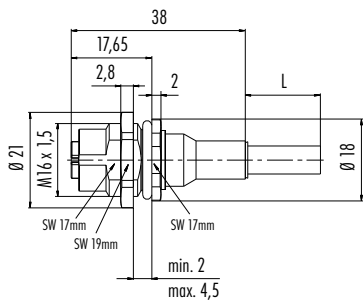

Bestell-Daten / Order Data

Polzahl Contacts	Kabelmantel Cable jacket	Kabellänge Cable length	Bestell-Nr. Ordering-No.
8	PUR	0,5 m	70 3784 706 08

Polzahl Contacts	Einbauhöhe Mounting height	Bestell-Nr. Ordering-No.
8	9 mm	99 3782 401 08
	13 mm	99 3782 402 08

Technische Daten / Specifications

Polzahl	8	8 SMT	Number of contacts
Steckverbinder Verriegelung		Schrauben/screw	Connector locking system
Anschlussart	PUR-Kabel/PUR-cable	SMT	Termination
Anschlussquerschnitt	AWG 26/7	—	Wire gauge
Kabeldurchlass		—	Cable outlet
Schutzart	IP67	IP68	Degree of protection
Mechanische Lebensdauer	> 100 Steckzyklen/> 100 mating cycles		Mechanical operation
Obere Grenztemperatur	+ 85 °C		Upper temperature
Untere Grenztemperatur	- 40 °C		Lower temperature
Bemessungsspannung	50 V AC, 60 V DC		Rated voltage
Übertragungseigenschaft	CAT 6 <sub>A</sub>		Rated impulse voltage
Verschmutzungsgrad	3		Pollution degree
Überspannungskategorie	II		Overvoltage categorie
Isolierstoffgruppe	II	III	Material group
Bemessungsstrom (40°C)	0,5 A		Rated current (40 °C)
Durchgangswiderstand	≤ 10 mΩ		Contact resistance
Material Kontakt	CuSn (Bronze/bronze)		Material of contact
Kontaktoberfläche	Au (Gold/gold)	Au (Gold/gold), Schirmblech/shielding sheet Sn (Zinn/tin)	Contact plating
Material Kontaktkörper	PA		Material of contact body
Material Gehäuse	CuZn (Messing/brass), Zink Druckguss vernickelt/zinc diecasting nickel plated	CuZn (Messing vernickelt/brass nickel plated)	Material of housing

**Kontaktsteinsatz mit X-Kodierung, tauchlöten, für Einbau in Kundengehäuse**  
 Contact insert with X-coding, dip solder, for mounting in customer housing

Abbildung / Figure



Maßzeichnung / Drawing

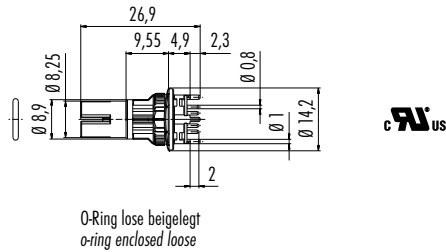

**Kontaktsteinsatz mit X-Kodierung, tauchlöten, gewinkelt, für Einbau in Kundengehäuse**  
 Contact insert with X-coding, dip solder, angled, for mounting in customer housing

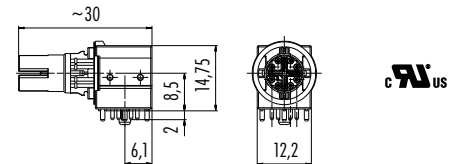

Bestell-Daten / Order Data

Polzahl Contacts	Bestell-Nr. Ordering-No.
8	09 3782 200 08

Polzahl Contacts	Bestell-Nr. Ordering-No.
8	09 3782 202 08

Technische Daten / Specifications

Polzahl	8	Number of contacts
Steckverbinder Verriegelung	schrauben/screw	Connector locking system
Anschlussart	tauchlöten/dip solder	Termination
Anschlussquerschnitt	—	Wire gauge
Kabeldurchlass	—	Cable outlet
Schutzart	IP67	Degree of protection
Mechanische Lebensdauer	> 100 Steckzyklen/> 100 mating cycles	Mechanical operation
Obere Grenztemperatur	+ 85 °C	Upper temperature
Untere Grenztemperatur	- 40 °C	Lower temperature
Bemessungsspannung	50 V AC, 60 V DC	Rated voltage
Übertragungseigenschaft	CAT 6 <sub>A</sub>	Rated impulse voltage
Verschmutzungsgrad	3	Pollution degree
Überspannungskategorie	II	Overvoltage categorie
Isolierstoffgruppe	III	Material group
Bemessungsstrom (40°C)	0,5 A	Rated current (40 °C)
Durchgangswiderstand	≤ 10 mΩ	Contact resistance
Material Kontakt	CuSn (Bronze/bronze)	Material of contact
Kontaktoberfläche	Au (Gold/gold)	Contact plating
Material Kontaktkörper	PA	Material of contact body
Material Gehäuse	—	Material of housing

**Adapter Schaltschrankdurchführung, Dose/Dose, geschirmt**  
 Adapter lead-through for control cabinet, female/female, shielded

Abbildung / Figure



Maßzeichnung / Drawing

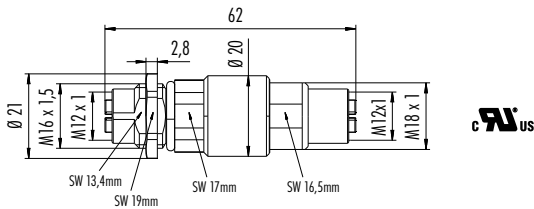

Bestell-Daten / Order Data

Polzahl Contacts	Bestell-Nr. Ordering-No.
8	09 5286 00 08

Technische Daten / Specifications

Polzahl	8	Number of contacts
Steckverbinder Verriegelung	Schrauben/screw	Connector locking system
Anschlussart	—	Termination
Anschlussquerschnitt	—	Wire gauge
Kabeldurchlass	—	Cable outlet
Schutzart	IP67	Degree of protection
Mechanische Lebensdauer	> 100 Steckzyklen/> 100 mating cycles	Mechanical operation
Obere Grenztemperatur	+ 85 °C	Upper temperature
Untere Grenztemperatur	- 40 °C	Lower temperature
Bemessungsspannung	50 V AC/60 V DC	Rated voltage
Bemessungs-Stoßspannung	800 V	Rated impulse voltage
Verschmutzungsgrad	3	Pollution degree
Überspannungskategorie	II	Overvoltage categorie
Isolierstoffgruppe	III	Material group
Bemessungsstrom (40°C)	0,5 A	Rated current (40 °C)
Durchgangswiderstand	≤ 10 mΩ	Contact resistance
Material Kontakt	CuSn (Bronze/bronze)	Material of contact
Kontaktoberfläche	Au (Gold/gold)	Contact plating
Material Kontaktkörper	PA	Material of contact body
Material Gehäuse	Zink Druckguss vernickelt/zinc diecasting nickel plated, CuZn (Messing vernickelt/brass nickel plated)	Material of housing

**Adapter Schaltschrankdurchführung, Dose – RJ45 gerade**  
 Adapter lead-through for control cabinet, female – RJ45 straight

Abbildung / Figure



**Adapter Schaltschrankdurchführung, Dose – RJ45 gewinkelt**  
 Adapter lead-through for control cabinet, female – RJ45 angled



Maßzeichnung / Drawing

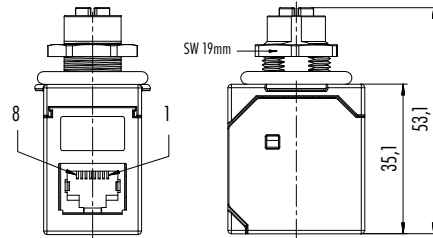
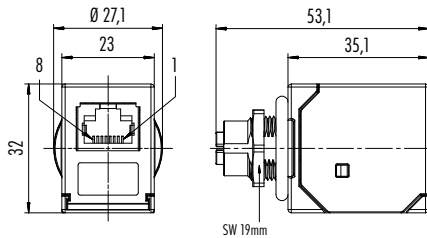

Bestell-Daten / Order Data

Polzahl Contacts	Bestell-Nr. Ordering-No.
8	09 5287 00 08

Polzahl Contacts	Bestell-Nr. Ordering-No.
8	09 5288 00 08

Technische Daten / Specifications

Polzahl	8	Number of contacts
Steckverbinder Verriegelung	schrauben/screw	Connector locking system
Anschlussart	—	Termination
Anschlussquerschnitt	—	Wire gauge
Kabeldurchlass	—	Cable outlet
Schutzart	IP67	Degree of protection
Mechanische Lebensdauer	> 100 Steckzyklen/> 100 mating cycles	Mechanical operation
Obere Grenztemperatur	+ 85 °C	Upper temperature
Untere Grenztemperatur	- 40 °C	Lower temperature
Bemessungsspannung	50 V AC/60 V DC	Rated voltage
Bemessungs-Stoßspannung	800 V	Rated impulse voltage
Verschmutzungsgrad	3	Pollution degree
Überspannungskategorie	II	Overvoltage categorie
Isolierstoffgruppe	III	Material group
Bemessungsstrom (40°C)	0,5 A	Rated current (40 °C)
Durchgangswiderstand	≤ 10 mΩ	Contact resistance
Material Kontakt	CuSn (Bronze/bronze)	Material of contact
Kontaktoberfläche	Au (Gold/gold)	Contact plating
Material Kontaktkörper	PA	Material of contact body
Material Gehäuse	Zink Druckguss vernickelt/zinc diecasting nickel plated, CuZn (Messing vernickelt/brass nickel plated)	Material of housing

**Einzelteildarstellung**  
Component part drawing

**Flanschsteckverbinder**  
Panel mount connectors

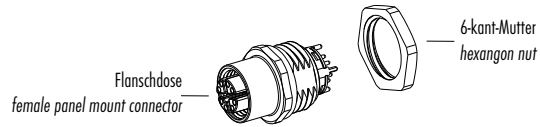

**Flanschsteckverbinder, von vorn verschraubbar**  
Panel mount connectors, front fastened

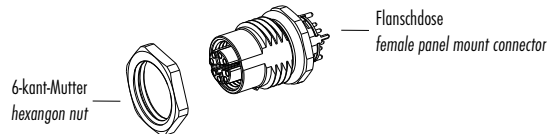

**Flanschsteckverbinder, Gehäusekontaktierung fest**  
Panel mount connectors, contact carrier fix

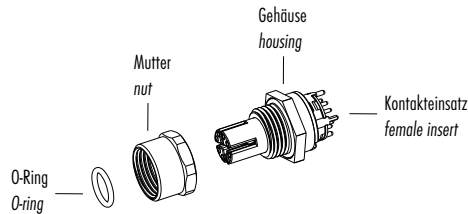

**Flanschsteckverbinder, Gehäusekontaktierung über Feder**  
Panel mount connectors, flexible mounting via undular washer

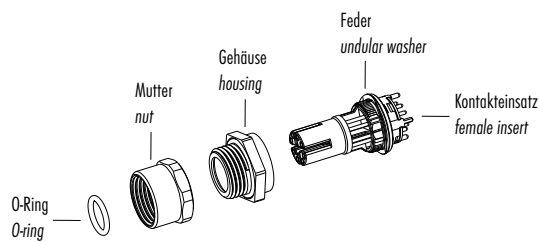

**Kontakteinsatz für Einbau in Kundengehäuse**  
Contact insert for mounting in customer housing

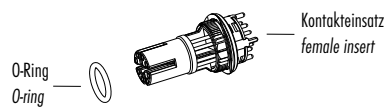

**Einbaudose, SMT, 9 mm**  
Female receptacle, SMT, 9 mm

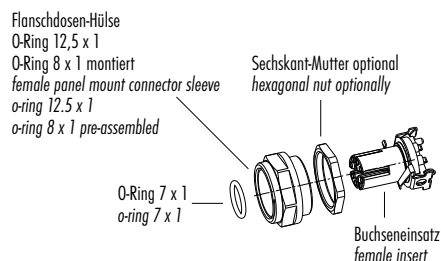

**Einbaudose, SMT, 13 mm**  
Female receptacle, SMT, 13 mm

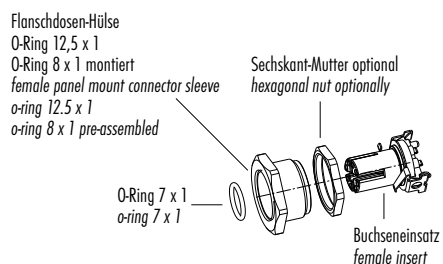

**Polbilder**  
Contact arrangements

**Stifteinsatz (Steckseite)**  
Male insert (mating side)

**Buchseinsatz (Steckseite)**  
Female insert (mating side)

8 pol  
8 contacts

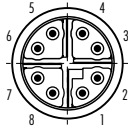

	X	Y
1	1,40	-2,80
2	2,80	-1,40
3	2,80	1,40
4	1,40	2,80
5	-1,40	2,80
6	-2,80	1,40
7	-2,80	-1,40
8	-1,40	-2,80

- 1 weiß-orange/white-orange
- 2 orange/orange
- 3 weiß-grün/white-green
- 4 grün/green
- 5 weiß-braun/white-brown
- 6 braun/brown
- 7 weiß-blau/white-blue
- 8 blau/blue

Schirm auf Gehäuse  
shield on housing

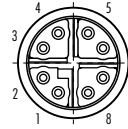

	X	Y
1	-1,40	-2,80
2	-2,80	-1,40
3	-2,80	1,40
4	-1,40	2,80
5	1,40	2,80
6	2,80	1,40
7	2,80	-1,40
8	1,40	-2,80

- 1 weiß-orange/white-orange
- 2 orange/orange
- 3 weiß-grün/white-green
- 4 grün/green
- 5 weiß-braun/white-brown
- 6 braun/brown
- 7 weiß-blau/white-blue
- 8 blau/blue

Schirm auf Gehäuse  
shield on housing

**Bohrbilder Buchseinsatz (Leiterplatte)**  
Drilling schemes female insert (PCB)

**Bohrbilder Buchseinsatz (Leiterplatte), Einbausteckverbinder**  
Drilling schemes female insert (PCB), receptacles

8 pol  
8 contacts

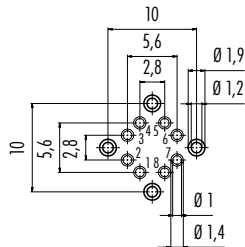

Ansicht Bestückungsseite  
Leiterplattendicke: 1,55 mm  
Alle Bohrungen durchkontaktiert

View of mating side  
Thickness of PCB: 1,55 mm  
All holes fully contacted

**Winkelversion**  
Angled version

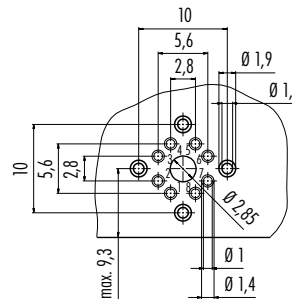

Ansicht Bestückungsseite  
Leiterplattendicke: 1,6 mm  
Alle Bohrungen (ausser  $\varnothing 2,85$ )  
durchkontaktiert.  
Cu 35/35

View of mating side  
Thickness of PCB: 1,6 mm  
All holes fully contacted  
(except  $\varnothing 2,85$ ).  
Cu 35/35

**Bohrbilder Buchseinsatz (Leiterplatte), SMT-Leiterplattenanschluss**  
Drilling schemes female insert (PCB), SMT-PCB mounting

8 pol  
8 contacts

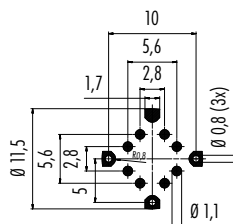

Montageausschnitt  
Panel cut out

Kabeldose  
Female cable connectors

Verwendung im Flansch mit geschnittenem Gewinde  
Use in flange with cutted thread

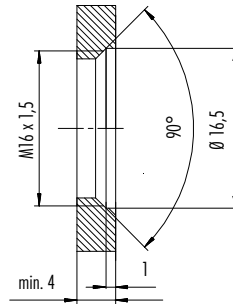

Flanschsteckverbinder  
Panel mount connectors

Mit Fläche als Verdrehschutz  
With flats as anti-rotation device

Mit Durchgangsbohrung  
With bore hole

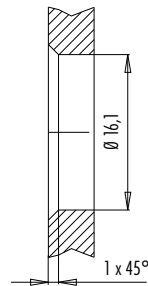
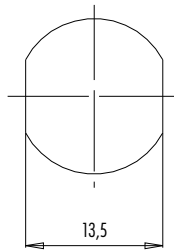

Flanschsteckverbinder, von vorn verschraubbar  
Panel mount connectors, front fastened

Mit Fläche als Verdrehschutz  
With flats as anti-rotation device

Mit Durchgangsbohrung  
With bore hole

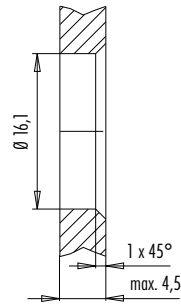
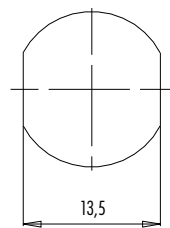

Flanschsteckverbinder mit Gewinde M12 x 1  
Panel mount connectors with M12 x 1 thread

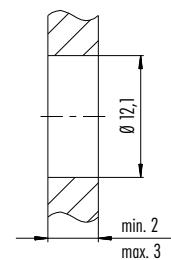
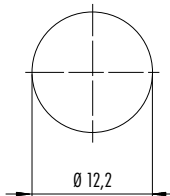

Anzugsdrehmoment/Tightening torque  
M12 x 1 6,25 Nm

Flanschsteckverbinder zweiteilig  
Panel mount connectors two halves

