



Bajonett Miniatur Bayonet Miniature

Kabelsteckverbinder

- Bajonett-Verriegelung
- 2 – 24-polig
- Schutzart IP40 ¹⁾
- Lötanschluss
- Durchmesser 19,9 – 20 mm
- Berührungssicheres Kunststoff-Gehäuse

Flanschsteckverbinder

- Bajonett Verriegelung
- 2 – 24-polig
- Schutzart IP40 ¹⁾
- Lötanschluss
- Durchmesser 19,9 – 21 mm

Cable Connectors

- Bayonet locking system
- 2 – 24 contacts
- Degree of protection IP40 ¹⁾
- Solder termination
- Diameter 19.9 – 20 mm
- Touch-proof plastic housing

Panel Mount Connectors

- Bayonet locking system
- 2 – 24 contacts
- Degree of protection IP40 ¹⁾
- Solder termination
- Diameter 19.9 – 21 mm

¹⁾Erläuterung der Schutzarten siehe technische Informationen./ ¹⁾Explanation of protection standards see technical information.

Kabelstecker
Male cable connector

Abbildung / Figure



Kabelstecker
Male cable connector



Maßzeichnung / Drawing

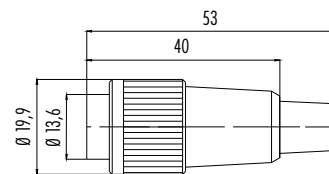
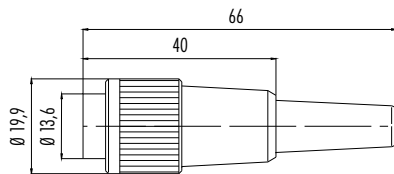

Bestell-Daten / Order Data

Polzahl Contacts	Kabeldurchlass Cable outlet	Bestell-Nr. Ordering-No.
2	3–6 mm	99 0601 00 02
3 DIN	3–6 mm	99 0605 00 03
4	3–6 mm	99 0609 00 04
5	3–6 mm	99 0613 00 05
6 DIN	3–6 mm	99 0617 00 06
7	3–6 mm	99 0621 00 07
7 DIN	3–6 mm	99 0681 00 07
8 DIN	3–6 mm	99 0645 00 08
12	3–6 mm	99 0649 00 12
14	3–6 mm	99 0653 00 14
16	3–6 mm	99 0657 00 16
19	3–6 mm	99 0665 00 19
24	3–6 mm	–

Polzahl Contacts	Kabeldurchlass Cable outlet	Bestell-Nr. Ordering-No.
2	6–8 mm	99 0601 02 02
3 DIN	6–8 mm	99 0605 02 03
4	6–8 mm	99 0609 02 04
5	6–8 mm	99 0613 02 05
6 DIN	6–8 mm	99 0617 02 06
7	6–8 mm	99 0621 02 07
7 DIN	6–8 mm	–
8 DIN	6–8 mm	99 0645 02 08
12	6–8 mm	99 0649 02 12
14	6–8 mm	99 0653 02 14
16	6–8 mm	99 0657 02 16
19	6–8 mm	99 0665 02 19
24	6–8 mm	99 0669 02 24

Technische Daten / Specifications

Polzahl	2	3 DIN	4	5	6 DIN	7	7 DIN	8 DIN	12	14	16	19	24	Number of contacts	
Steckverbinder Verriegelung	Bajonett/bayonet													Connector locking system	
Anschlussart	löten/solder													Termination	
Anschlussquerschnitt	max. 0,75 mm ² (max. AWG 18)						max. 0,25 mm ² (max. AWG 24)				0,14 mm ² (26)			Wire gauge	
Kabeldurchlass	3–6 mm, 6–8 mm													Cable outlet	
Schutzart	IP40													Degree of protection	
Mechanische Lebensdauer	> 1000 Steckzyklen/> 1000 mating cycles						> 500		> 1000 Steckzyklen/> 1000 mating cycles				> 500		Mechanical operation
Obere Grenztemperatur	+ 85 °C													Upper temperature	
Untere Grenztemperatur	– 40 °C													Lower temperature	
Bemessungsspannung	150 V (250 V)				32 V (125 V)				32 V (60 V)					Rated voltage	
Bemessungs-Stoßspannung	1500 V				500 V (800 V)				500 V					Rated impulse voltage	
Verschmutzungsgrad	2 (I) ¹⁾													Pollution degree	
Überspannungskategorie	II (I) ¹⁾													Overvoltage categorie	
Isolierstoffgruppe	III													Material group	
Bemessungsstrom (40 °C)	7 A		6 A		5 A				3 A			1 A			Rated current (40 °C)
Durchgangswiderstand	≤ 5 mΩ													Contact resistance	
Material Kontakt	CuZn (Messing/brass)													Material of contact	
Kontaktoberfläche	Ag (Silber/silver)						Au (Gold/gold)								Contact plating
Material Kontaktkörper	PBT													Material of contact body	
Material Gehäuse	PA													Material of housing	

Winkelstecker
Male angled connector

Abbildung / Figure



Winkelstecker
Male angled connector



Maßzeichnung / Drawing

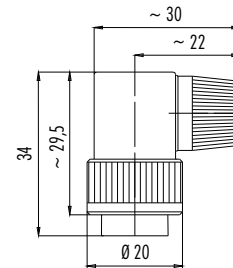
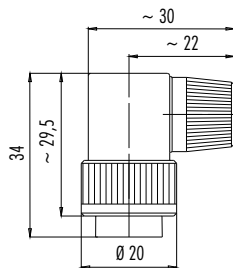

Bestell-Daten / Order Data

Polzahl Contacts	Kabeldurchlass Cable outlet	Bestell-Nr. Ordering-No.
2	4–6 mm	99 0601 70 02
3 DIN	4–6 mm	99 0605 70 03
4	4–6 mm	99 0609 70 04
5	4–6 mm	99 0613 70 05
6 DIN	4–6 mm	99 0617 70 06
7	4–6 mm	99 0621 70 07
7 DIN	4–6 mm	99 0681 70 07
8 DIN	4–6 mm	99 0645 70 08
12	4–6 mm	99 0649 70 12
14	4–6 mm	99 0653 70 14
16	4–6 mm	99 0657 70 16
19	4–6 mm	99 0665 70 19
24	4–6 mm	–

Polzahl Contacts	Kabeldurchlass Cable outlet	Bestell-Nr. Ordering-No.
2	6–8 mm	99 0601 72 02
3 DIN	6–8 mm	99 0605 72 03
4	6–8 mm	99 0609 72 04
5	6–8 mm	99 0613 72 05
6 DIN	6–8 mm	99 0617 72 06
7	6–8 mm	99 0621 72 07
7 DIN	6–8 mm	–
8 DIN	6–8 mm	99 0645 72 08
12	6–8 mm	99 0649 72 12
14	6–8 mm	99 0653 72 14
16	6–8 mm	99 0657 72 16
19	6–8 mm	99 0665 72 19
24	6–8 mm	99 0669 72 24

Technische Daten / Specifications

Polzahl	2	3 DIN	4	5	6 DIN	7	7 DIN	8 DIN	12	14	16	19	24	Number of contacts	
Steckverbinder Verriegelung	Bajonett/bayonet													Connector locking system	
Anschlussart	löten/solder													Termination	
Anschlussquerschnitt	max. 0,75 mm ² (max. AWG 18)						max. 0,25 mm ² (max. AWG 24)			0,14 mm ² (26)				Wire gauge	
Kabeldurchlass	4–6 mm, 6–8 mm													Cable outlet	
Schutzart	IP40													Degree of protection	
Mechanische Lebensdauer	> 1000 Steckzyklen/> 1000 mating cycles						> 500			> 1000 Steckzyklen/> 1000 mating cycles				> 500	Mechanical operation
Obere Grenztemperatur	+ 85 °C													Upper temperature	
Untere Grenztemperatur	– 40 °C													Lower temperature	
Bemessungsspannung	150 V (250 V)				32 V (125 V)				32 V (60 V)					Rated voltage	
Bemessungs-Stoßspannung	1500 V				500 V (800 V)				500 V					Rated impulse voltage	
Verschmutzungsgrad	2 (I) ¹⁾													Pollution degree	
Überspannungskategorie	II (I) ¹⁾													Overvoltage categorie	
Isolierstoffgruppe	III													Material group	
Bemessungsstrom (40°C)	7 A		6 A		5 A				3 A			1 A		Rated current (40 °C)	
Durchgangswiderstand	≤ 5 mΩ													≤ 3 mΩ	Contact resistance
Material Kontakt	CuZn (Messing/brass)													Material of contact	
Kontaktoberfläche	Ag (Silber/silver)						Au (Gold/gold)					Contact plating			
Material Kontaktkörper	PBT													Material of contact body	
Material Gehäuse	PA													Material of housing	

¹⁾ Bei Verschm.grad 1, Übersp.kat. I reduzierte Bemessungsspannung./ ¹⁾ In case of pollution degree 1, overvoltage category I rated voltage is reduced.

Kabeldose
Female cable connector

Abbildung / Figure



Kabeldose
Female cable connector



Maßzeichnung / Drawing

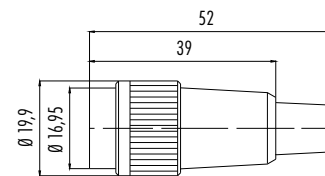
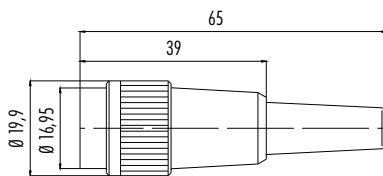

Bestell-Daten / Order Data

Polzahl Contacts	Kabeldurchlass Cable outlet	Bestell-Nr. Ordering-No.
2	3–6 mm	99 0602 00 02
3 DIN	3–6 mm	99 0606 00 03
4	3–6 mm	99 0610 00 04
5	3–6 mm	99 0614 00 05
6 DIN	3–6 mm	99 0618 00 06
7	3–6 mm	99 0622 00 07
7 DIN	3–6 mm	99 0682 00 07
8 DIN	3–6 mm	99 0646 00 08
12	3–6 mm	99 0650 00 12
14	3–6 mm	99 0654 00 14
16	3–6 mm	99 0658 00 16
19	3–6 mm	99 0666 00 19
24	3–6 mm	–

Polzahl Contacts	Kabeldurchlass Cable outlet	Bestell-Nr. Ordering-No.
2	6–8 mm	99 0602 02 02
3 DIN	6–8 mm	99 0606 02 03
4	6–8 mm	99 0610 02 04
5	6–8 mm	99 0614 02 05
6 DIN	6–8 mm	99 0618 02 06
7	6–8 mm	99 0622 02 07
7 DIN	6–8 mm	–
8 DIN	6–8 mm	99 0646 02 08
12	6–8 mm	99 0650 02 12
14	6–8 mm	99 0654 02 14
16	6–8 mm	99 0658 02 16
19	6–8 mm	99 0666 02 19
24	6–8 mm	99 0670 02 24

Technische Daten / Specifications

Polzahl	2	3 DIN	4	5	6 DIN	7	7 DIN	8 DIN	12	14	16	19	24	Number of contacts	
Steckverbinder Verriegelung	Bajonett/bayonet													Connector locking system	
Anschlussart	löten/solder													Termination	
Anschlussquerschnitt	max. 0,75 mm ² (max. AWG 18)						max. 0,25 mm ² (max. AWG 24)				0,14 mm ² (26)			Wire gauge	
Kabeldurchlass	3–6 mm, 6–8 mm													Cable outlet	
Schutzart	IP40													Degree of protection	
Mechanische Lebensdauer	> 1000 Steckzyklen/> 1000 mating cycles						> 500		> 1000 Steckzyklen/> 1000 mating cycles				> 500		Mechanical operation
Obere Grenztemperatur	+ 85 °C													Upper temperature	
Untere Grenztemperatur	– 40 °C													Lower temperature	
Bemessungsspannung	150 V (250 V)				32 V (125 V)				32 V (60 V)				Rated voltage		
Bemessungs-Stoßspannung	1500 V				500 V (800 V)				500 V				Rated impulse voltage		
Verschmutzungsgrad	2 (I) ¹⁾													Pollution degree	
Überspannungskategorie	II (I) ¹⁾													Overvoltage categorie	
Isolierstoffgruppe	III													Material group	
Bemessungsstrom (40 °C)	7 A		6 A		5 A				3 A		1 A			Rated current (40 °C)	
Durchgangswiderstand	≤ 5 mΩ													Contact resistance	
Material Kontakt	CuSn (Bronze/bronze)													Material of contact	
Kontaktoberfläche	Ag (Silber/silver)						Au (Gold/gold)							Contact plating	
Material Kontaktkörper	PBT													Material of contact body	
Material Gehäuse	PA													Material of housing	

Winkeldose
Female angled connector

Abbildung / Figure



Winkeldose
Female angled connector



Maßzeichnung / Drawing

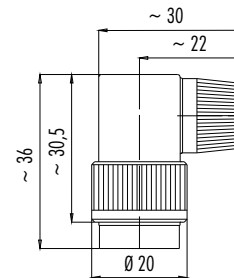
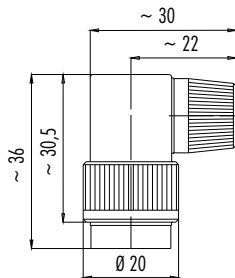

Bestell-Daten / Order Data

Polzahl Contacts	Kabeldurchlass Cable outlet	Bestell-Nr. Ordering-No.
2	4–6 mm	99 0602 70 02
3 DIN	4–6 mm	99 0606 70 03
4	4–6 mm	99 0610 70 04
5	4–6 mm	99 0614 70 05
6 DIN	4–6 mm	99 0618 70 06
7	4–6 mm	99 0622 70 07
7 DIN	4–6 mm	99 0682 70 07
8 DIN	4–6 mm	99 0646 70 08
12	4–6 mm	99 0650 70 12
14	4–6 mm	99 0654 70 14
16	4–6 mm	99 0658 70 16
19	4–6 mm	99 0666 70 19
24	4–6 mm	–

Polzahl Contacts	Kabeldurchlass Cable outlet	Bestell-Nr. Ordering-No.
2	6–8 mm	99 0602 72 02
3 DIN	6–8 mm	99 0606 72 03
4	6–8 mm	99 0610 72 04
5	6–8 mm	99 0614 72 05
6 DIN	6–8 mm	99 0618 72 06
7	6–8 mm	99 0622 72 07
7 DIN	6–8 mm	–
8 DIN	6–8 mm	99 0646 72 08
12	6–8 mm	99 0650 72 12
14	6–8 mm	99 0654 72 14
16	6–8 mm	99 0658 72 16
19	6–8 mm	99 0666 72 19
24	6–8 mm	99 0670 72 24

Technische Daten / Specifications

Polzahl	2	3 DIN	4	5	6 DIN	7	7 DIN	8 DIN	12	14	16	19	24	Number of contacts	
Steckverbinder Verriegelung	Bajonett/bayonet													Connector locking system	
Anschlussart	löten/solder													Termination	
Anschlussquerschnitt	max. 0,75 mm ² (max. AWG 18)						max. 0,25 mm ² (max. AWG 24)			0,14 mm ² (26)				Wire gauge	
Kabeldurchlass	4–6 mm, 6–8 mm													Cable outlet	
Schutzart	IP40													Degree of protection	
Mechanische Lebensdauer	> 1000 Steckzyklen/> 1000 mating cycles						> 500			> 1000 Steckzyklen/> 1000 mating cycles				> 500	Mechanical operation
Obere Grenztemperatur	+ 85 °C													Upper temperature	
Untere Grenztemperatur	– 40 °C													Lower temperature	
Bemessungsspannung	150 V (250 V)				32 V (125 V)				32 V (60 V)						Rated voltage
Bemessungs-Stoßspannung	1500 V				500 V (800 V)				500 V						Rated impulse voltage
Verschmutzungsgrad	2 (I) ¹⁾													Pollution degree	
Überspannungskategorie	II (I) ¹⁾													Overvoltage categorie	
Isolierstoffgruppe	III													Material group	
Bemessungsstrom (40°C)	7 A		6 A		5 A				3 A			1 A		Rated current (40 °C)	
Durchgangswiderstand	≤ 5 mΩ													≤ 3 mΩ	Contact resistance
Material Kontakt	CuSn (Bronze/bronze)													Material of contact	
Kontaktoberfläche	Ag (Silber/silver)						Au (Gold/gold)						Contact plating		
Material Kontaktkörper	PBT													Material of contact body	
Material Gehäuse	PA													Material of housing	

¹⁾ Bei Verschm.grad 1, Übersp.kat. I reduzierte Bemessungsspannung./ ¹⁾ In case of pollution degree 1, overvoltage category I rated voltage is reduced.

Einzelteildarstellung
Component part drawing

Kabelstecker
Male cable connector

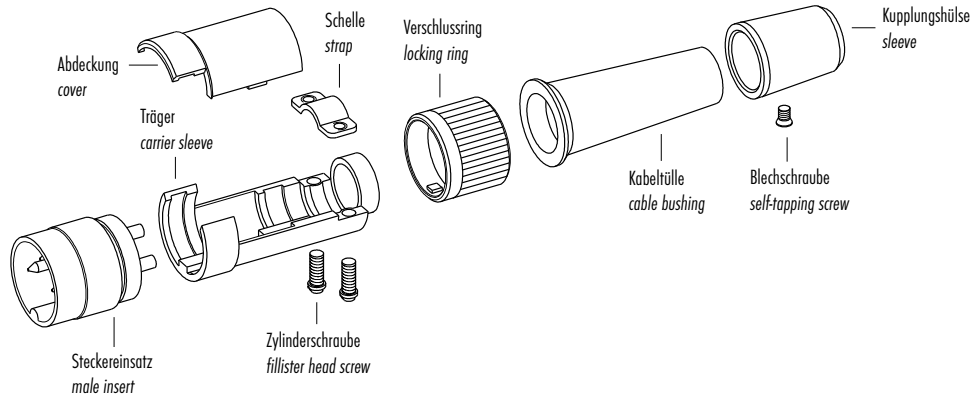

Kabeldose
Female cable connector

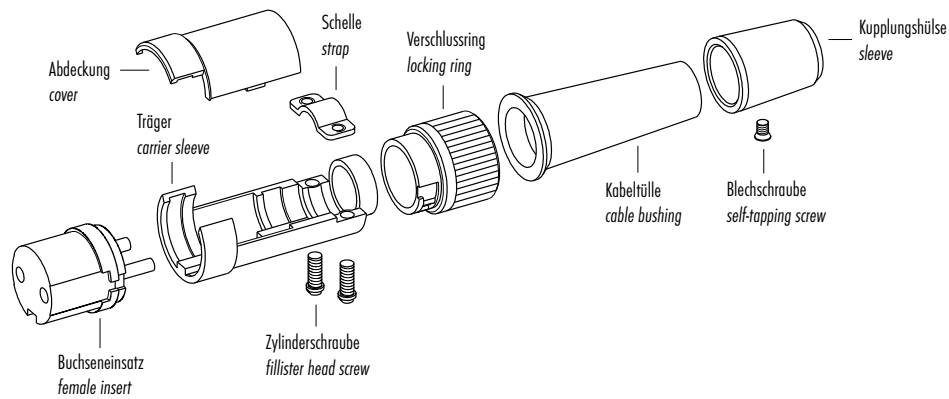

Winkelstecker
Male angled connector

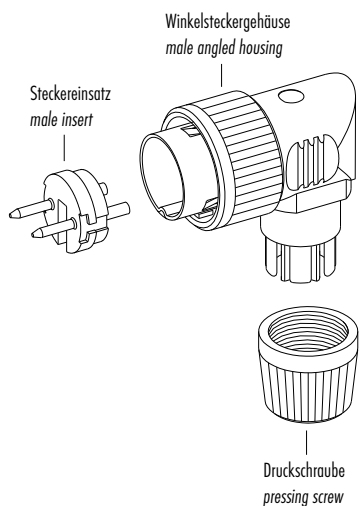

Winkeldose
Female angled connector

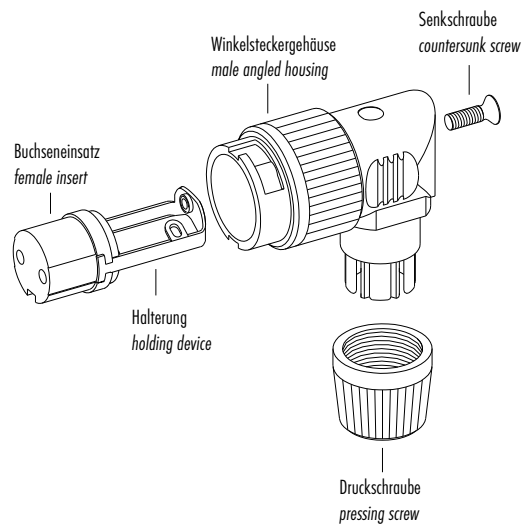

Flanschstecker
Male panel mount connector

Abbildung / Figure



Flanschdose
Female panel mount connector



Maßzeichnung / Drawing

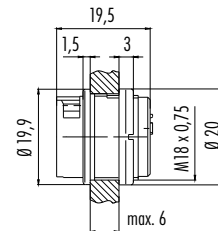
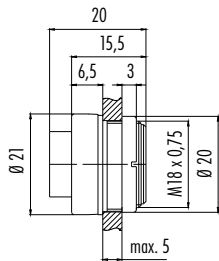

Bestell-Daten / Order Data

Polzahl Contacts	Bestell-Nr. Ordering-No.
2	99 0603 00 02
3 DIN	99 0607 00 03
4	99 0611 00 04
5	99 0615 00 05
6 DIN	99 0619 00 06
7	99 0623 00 07
7 DIN	99 0683 00 07
8 DIN	99 0647 00 08
12	99 0651 00 12
14	99 0655 00 14
16	99 0659 00 16
19	99 0667 00 19
24	99 0671 00 24

Polzahl Contacts	Bestell-Nr. Ordering-No.
2	99 0604 00 02
3 DIN	99 0608 00 03
4	99 0612 00 04
5	99 0616 00 05
6 DIN	99 0620 00 06
7	99 0624 00 07
7 DIN	99 0684 00 07
8 DIN	99 0648 00 08
12	99 0652 00 12
14	99 0656 00 14
16	99 0660 00 16
19	99 0668 00 19
24	99 0672 00 24

Technische Daten / Specifications

Polzahl	2	3 DIN	4	5	6 DIN	7	7 DIN	8 DIN	12	14	16	19	24	Number of contacts	
Steckverbinder Verriegelung	Bajonett/bayonet													Connector locking system	
Anschlussart	löten/solder													Termination	
Anschlussquerschnitt	max. 0,75 mm ² (max. AWG 18)						max. 0,25 mm ² (max. AWG 24)			0,14 mm ² (26)				Wire gauge	
Kabeldurchlass	—													Cable outlet	
Schutzart	IP40													Degree of protection	
Mechanische Lebensdauer	> 1000 Steckzyklen/> 1000 mating cycles						> 500			> 1000 Steckzyklen/> 1000 mating cycles				> 500	Mechanical operation
Obere Grenztemperatur	+ 85 °C													Upper temperature	
Untere Grenztemperatur	- 40 °C													Lower temperature	
Bemessungsspannung	150 V (250 V)				32 V (125 V)				32 V (60 V)					Rated voltage	
Bemessungs-Stoßspannung	1500 V				500 V (800 V)				500 V					Rated impulse voltage	
Verschmutzungsgrad	2 (I) ¹⁾													Pollution degree	
Überspannungskategorie	II (I) ¹⁾													Overvoltage categorie	
Isolierstoffgruppe	III													Material group	
Bemessungsstrom (40°C)	7 A		6 A			5 A			3 A			1 A			Rated current (40 °C)
Durchgangswiderstand	≤ 5 mΩ													≤ 3 mΩ	Contact resistance
Material Kontakt	Stift/pin CuZn (Messing/brass), Buchse/socket CuSn (Bronze/bronze)													Material of contact	
Kontaktoberfläche	Ag (Silber/silver)						Au (Gold/gold)							Contact plating	
Material Kontaktkörper	PBT													Material of contact body	
Material Gehäuse	PA													Material of housing	

¹⁾ Bei Verschm.grad 1, Übersp.kat. I reduzierte Bemessungsspannung./ ¹⁾ In case of pollution degree 1, overvoltage category I rated voltage is reduced.

Polbilder
Contact arrangements

Stifteinsatz (Steckseite)
Male insert (mating side)

Buchseinsatz (Steckseite)
Female insert (mating side)

2 pol
2 contacts

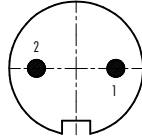

	X	Y
1	3,50	0,00
2	-3,50	0,00

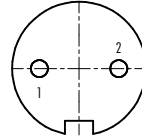

	X	Y
1	-3,50	0,00
2	3,50	0,00

3 pol (DIN 41524)
3 contacts (DIN 41524)

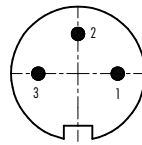

	X	Y
1	3,50	0,00
2	0,00	3,50
3	-3,50	0,00

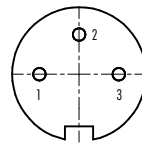

	X	Y
1	-3,50	0,00
2	0,00	3,50
3	3,50	0,00

4 pol
4 contacts

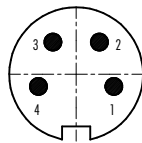

	X	Y
1	3,32	-1,08
2	2,05	2,83
3	-2,05	2,83
4	-3,32	-1,08

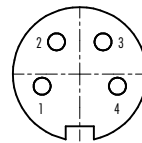

	X	Y
1	-3,32	-1,08
2	-2,05	2,83
3	2,05	2,83
4	3,32	-1,08

5 pol
5 contacts

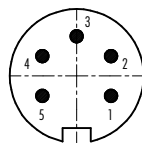

	X	Y
1	3,03	-1,75
2	3,03	1,75
3	0,00	3,50
4	-3,03	1,75
5	-3,03	-1,75

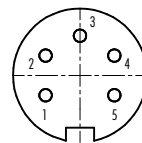

	X	Y
1	-3,03	-1,75
2	-3,03	1,75
3	0,00	3,50
4	3,03	1,75
5	3,03	-1,75

6 pol (DIN 45322)
6 contacts (DIN 45322)

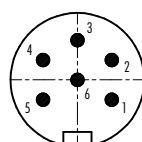

	X	Y
1	3,03	-1,75
2	3,03	1,75
3	0,00	3,50
4	-3,03	1,75
5	-3,03	-1,75
6	0,00	0,00

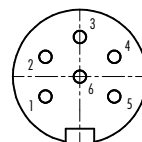

	X	Y
1	-3,03	-1,75
2	-3,03	1,75
3	0,00	3,50
4	3,03	1,75
5	3,03	-1,75
6	0,00	0,00

Polbilder
Contact arrangements

Stifteinsatz (Steckseite)
Male insert (mating side)

Buchseinsatz (Steckseite)
Female insert (mating side)

7 pol
7 contacts

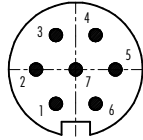

	X	Y
1	-1,75	-3,03
2	-3,50	0,00
3	-1,75	3,03
4	1,75	3,03
5	3,50	0,00
6	1,75	-3,03
7	0,00	0,00

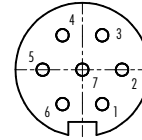

	X	Y
1	1,75	-3,03
2	3,50	0,00
3	1,75	3,03
4	-1,75	3,03
5	-3,50	0,00
6	-1,75	-3,03
7	0,00	0,00

7 pol (DIN 45329)
7 contacts (DIN 45329)

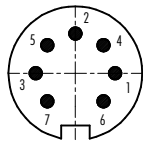

	X	Y
1	3,50	0,00
2	0,00	3,50
3	-3,50	0,00
4	2,47	2,47
5	-2,47	2,47
6	2,47	-2,47
7	-2,47	-2,47

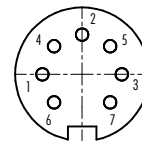

	X	Y
1	-3,50	0,00
2	0,00	3,50
3	3,50	0,00
4	-2,47	2,47
5	2,47	2,47
6	-2,47	-2,47
7	2,47	-2,47

8 pol (DIN 45326)
8 contacts (DIN 45326)

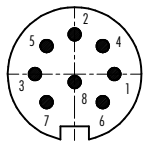

	X	Y
1	3,50	0,00
2	0,00	3,50
3	-3,50	0,00
4	2,47	2,47
5	-2,47	2,47
6	2,47	-2,47
7	-2,47	-2,47
8	0,00	-0,70

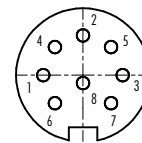

	X	Y
1	-3,50	0,00
2	0,00	3,50
3	3,50	0,00
4	-2,47	2,47
5	2,47	2,47
6	-2,47	-2,47
7	2,47	-2,47
8	0,00	-0,70

12 pol
12 contacts

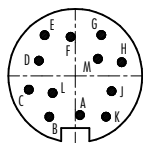

	X	Y
A	0,41	-3,45
B	-2,29	-3,61
C	-4,10	-1,21
D	-3,20	1,34
E	-2,71	3,59
F	-0,41	3,45
G	2,29	3,61
H	4,10	1,21
J	3,20	-1,34
K	2,71	-3,59
L	-2,00	-1,51
M	2,00	1,51

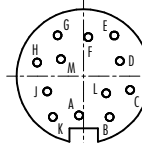

	X	Y
A	-0,41	-3,45
B	2,29	-3,61
C	4,10	-1,21
D	3,20	1,34
E	2,71	3,59
F	0,41	3,45
G	-2,29	3,61
H	-4,10	1,21
J	-3,20	-1,34
K	-2,71	-3,59
L	-2,00	-1,51
M	2,00	1,51

14 pol
14 contacts

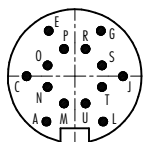

	X	Y
A	-2,50	-4,00
C	-4,25	0,00
E	-2,30	4,00
G	2,30	4,00
J	4,25	0,00
L	2,50	-4,00
M	-0,95	-2,40
N	-2,40	-0,95
O	-2,40	0,95
P	-0,95	2,40
R	0,95	2,40
S	2,40	0,95
T	2,40	-0,95
U	0,95	-2,40

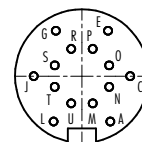

	X	Y
A	2,50	-4,00
C	4,25	0,00
E	2,30	4,00
G	-2,30	4,00
J	-4,25	0,00
L	-2,50	-4,00
M	0,95	-2,40
N	2,40	-0,95
O	2,40	0,95
P	0,95	2,40
R	-0,95	2,40
S	-2,40	0,95
T	-2,40	-0,95
U	-0,95	-2,40

Polbilder
Contact arrangements

Stifteinsatz (Steckseite)
Male insert (mating side)

Buchseinsatz (Steckseite)
Female insert (mating side)

16 pol
16 contacts

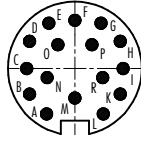

	X	Y
A	-2,50	-4,00
B	-4,00	-2,25
C	-4,25	0,00
D	-4,00	2,40
E	-2,30	4,00
F	0,00	4,25
G	2,30	4,00
H	4,00	2,40
I	4,25	0,00
K	4,00	-2,25
L	2,50	-4,00
M	0,00	-2,60
N	-2,45	-0,80
O	-1,50	2,10
P	1,50	2,10
R	2,40	-0,80

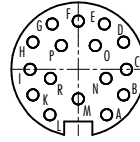

	X	Y
A	2,50	-4,00
B	4,00	-2,25
C	4,25	0,00
D	4,00	2,40
E	2,30	4,00
F	0,00	4,25
G	-2,30	4,00
H	-4,00	2,40
I	-4,25	0,00
K	-4,00	-2,25
L	-2,50	-4,00
M	0,00	-2,60
N	2,45	-0,80
O	1,50	2,10
P	-1,50	2,10
R	-2,40	-0,80

19 pol
19 contacts

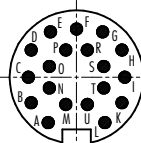

	X	Y
A	-2,50	-4,00
B	-4,00	-2,25
C	-4,25	0,00
D	-4,00	2,40
E	-2,30	4,00
F	0,00	4,25
G	2,30	4,00
H	4,00	2,40
I	4,25	0,00
K	4,00	-2,25
L	2,50	-4,00
M	-0,95	-2,40
N	-2,40	-0,95
O	-2,40	0,95
P	-0,95	2,40
R	0,95	2,40
S	2,40	0,95
T	2,40	-0,95
U	0,95	-2,40

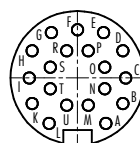

	X	Y
A	2,50	-4,00
B	4,00	-2,25
C	4,25	0,00
D	4,00	2,40
E	2,30	4,00
F	0,00	4,25
G	-2,30	4,00
H	-4,00	2,40
I	-4,25	0,00
K	-4,00	-2,25
L	-2,50	-4,00
M	0,95	-2,40
N	2,40	-0,95
O	2,40	0,95
P	0,95	2,40
R	-0,95	2,40
S	-2,40	0,95
T	-2,40	-0,95
U	-0,95	-2,40

24 pol
24 contacts

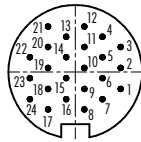

	X	Y
1	4,00	-1,50
2	4,00	0,35
3	4,00	2,20
4	2,40	3,10
5	2,40	1,30
6	2,40	-0,55
7	2,40	-2,40
8	0,80	-3,30
9	0,80	-1,50
10	0,80	0,35
11	0,80	2,20
12	0,80	4,00
13	-0,80	3,10
14	-0,80	1,30
15	-0,80	-0,55
16	-0,80	-2,40
17	-2,40	-3,30
18	-2,40	-1,50
19	-2,40	0,35
20	-2,40	2,20
21	-2,40	4,00
22	-4,00	1,30
23	-4,00	-0,55
24	-4,00	-2,40

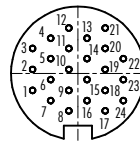

	X	Y
1	-4,00	-1,50
2	-4,00	0,35
3	-4,00	2,20
4	-2,40	3,10
5	-2,40	1,30
6	-2,40	-0,55
7	-2,40	-2,40
8	-0,80	-3,30
9	-0,80	-1,50
10	-0,80	0,35
11	-0,80	2,20
12	-0,80	4,00
13	0,80	3,10
14	0,80	1,30
15	0,80	-0,55
16	0,80	-2,40
17	2,40	-3,30
18	2,40	-1,50
19	2,40	0,35
20	2,40	2,20
21	2,40	4,00
22	4,00	1,30
23	4,00	-0,55
24	4,00	-2,40

Montageausschnitt
Panel cut out

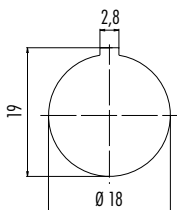

Blindstopfen, IP67
Blind plug, IP67

Abbildung / Figure



Maßzeichnung / Drawing

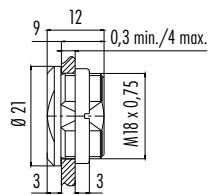

Bestell-Daten / Order Data

Bestell-Nr.
Ordering-No.

08 2668 000 001

Sechskantmutter
Hexagonal nut

Abbildung / Figure



Maßzeichnung / Drawing

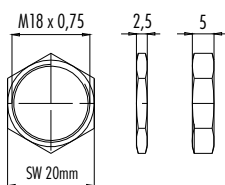

Bestell-Daten / Order Data

Stärke Thickness	Bestell-Nr. Ordering-No.
2,5 mm	01 0146 001
5 mm	01 5006 001

Montageschlüssel für Flanschsteckverbinder
Mounting spanner for panel mount connectors



Maßzeichnung / Drawing

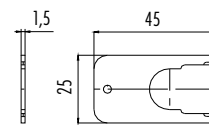

Bestell-Nr.
Ordering-No.

07 0010 001

Ringmutter für Befestigungsgewinde
Ring nut for fixing thread



Maßzeichnung / Drawing

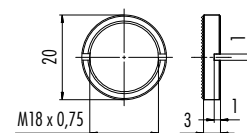

Bestell-Nr.
Ordering-No.

01 0010 001 Mit Rändel/with knurled screw

Viereckflansch für Flanschsteckverbinder, IP40
Rectangular flange for panel mount connectors, IP40

Abbildung / Figure



Maßzeichnung / Drawing

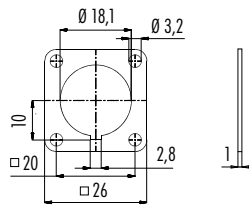

Bestell-Daten / Order Data

Bestell-Nr.
Ordering-No.

04 0106 001

